



Effektstyrning vid elbilsladdning

Quick Start Guide



1x EneGic Monitor
mätenhet

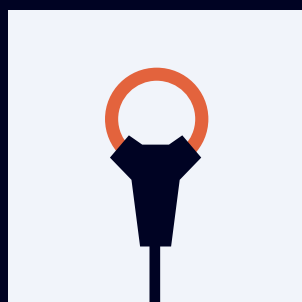

3x Strömsensorer

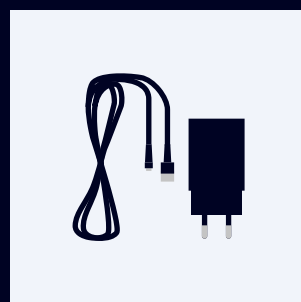

1x USB laddare alt.
DIN Adapter

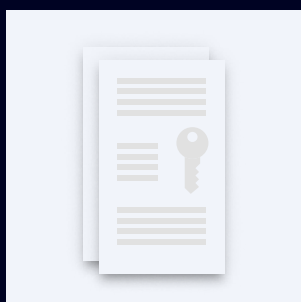

1x Licens

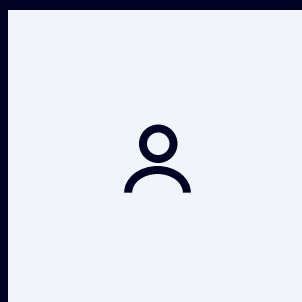

Installatörskonto

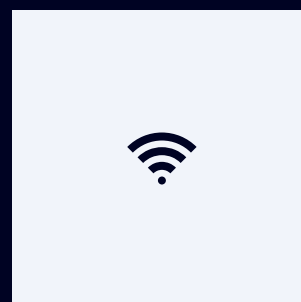

2,4 GHz WiFi



Scan the code to see
our installation and
configuration videos!

enegic.com

1

Installation

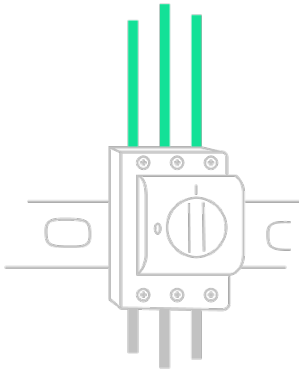

- 1** Locate the phase conductors. Usually, L1 is brown, L2 black and L3 gray.

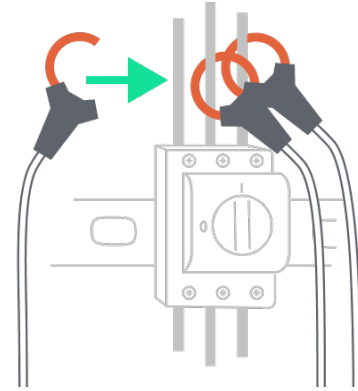

- 2** Tighten the current sensors around the phase conductors. Connect the current sensors so that the consumption of the entire property is measured.

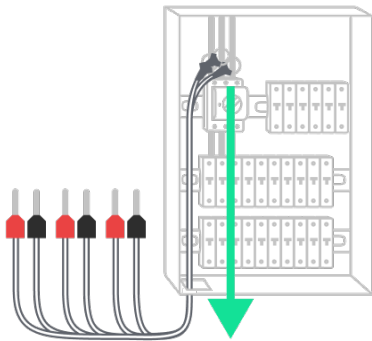

- 3** Pull the cables out of the electrical cabinet.

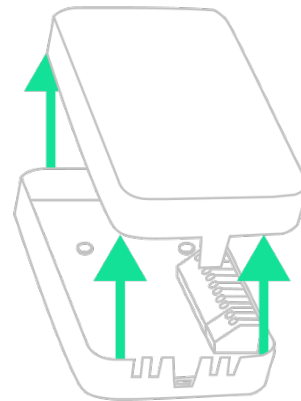

- 4** Open the measuring unit.

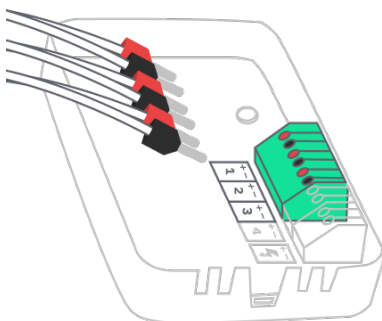

- 5** Plug the current sensors into the terminal block. L1 to 1, L2 to 2 and L3 to 3..

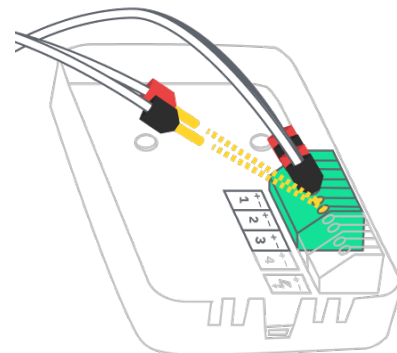

- 5b** Connect cables with **red pins to +**, and cables with **black pins to -**.

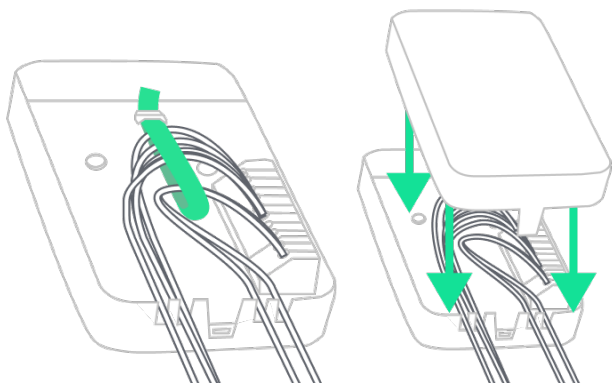

- 6** Fasten the cables with cable ties and put back the cover.

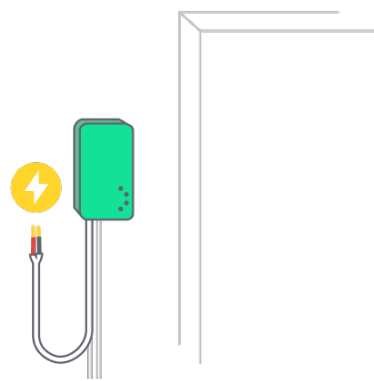

- 7** Power the device with the included DIN or USB and attach the device outside the electrical cabinet with the included Velcro strap.

2

Konfiguration

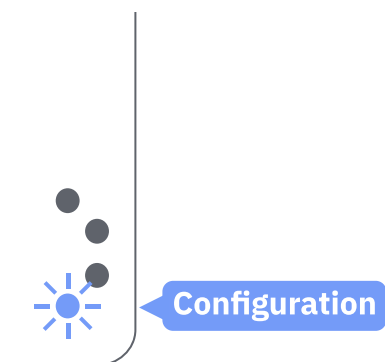

- 1** **Kontrollera att enheten är i konfigurationsläge:**
Om inte, tryck på den nedersta knappen i 10 sek tills den börjar blinka blått.

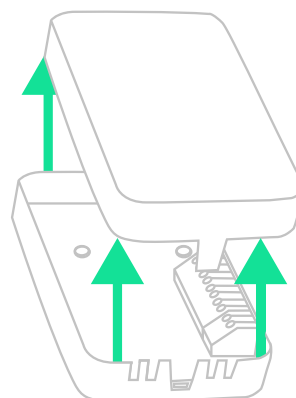

- 2** Ladda ned enegic-appen och logga in med ditt installatörskonto

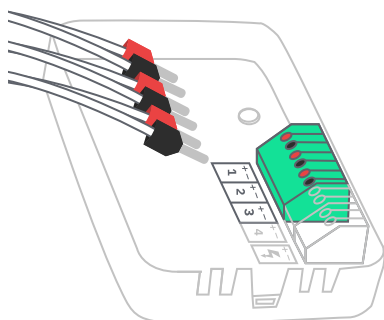

- 3** Lägg till ny enhet & koppla upp mot 2,4 GHz WiFi

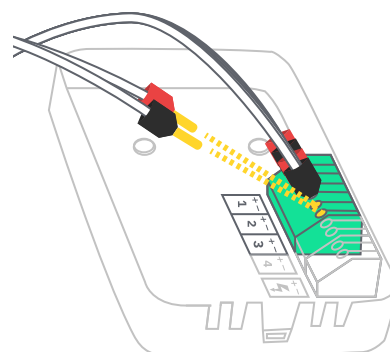

- 4** Skanna licens

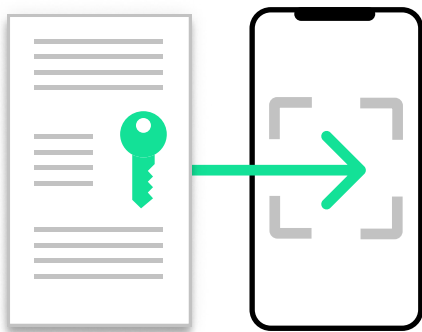

5 Skanna medföljande licens

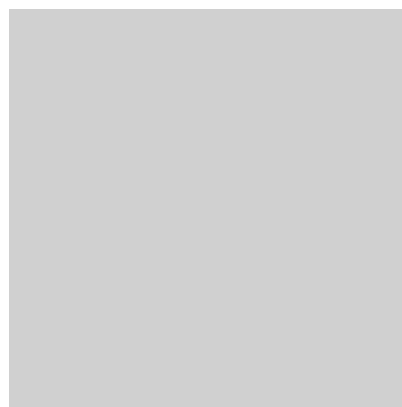

6 Skapa rapportör

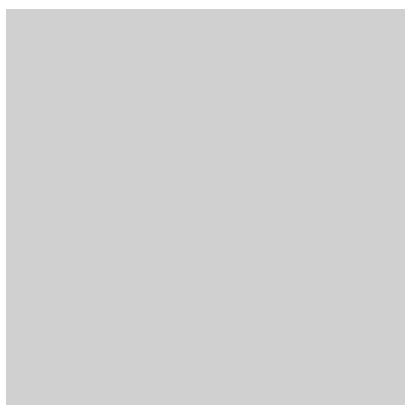

7 Charge Amps

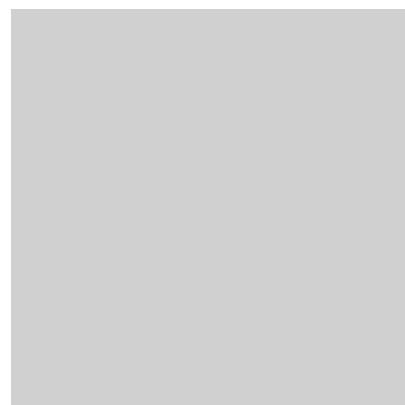

8 Charge Amps

3

Felsökning

