

EUROLAN Wall cabinet

**IP55 IN/OUTDOOR 600X450 7/9/12U**

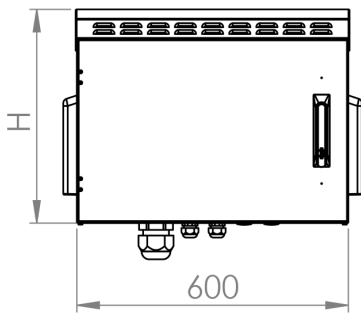

FRONT VIEW

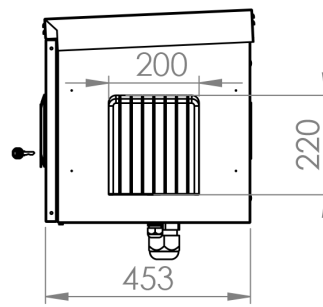

SIDE VIEW

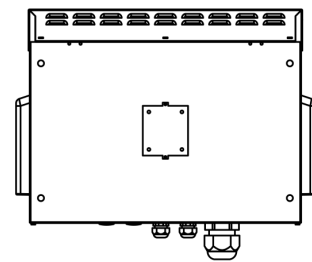

REAR VIEW



TOP VIEW

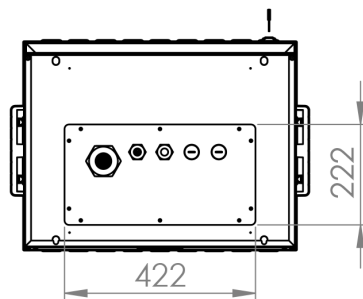

BOTTOM VIEW

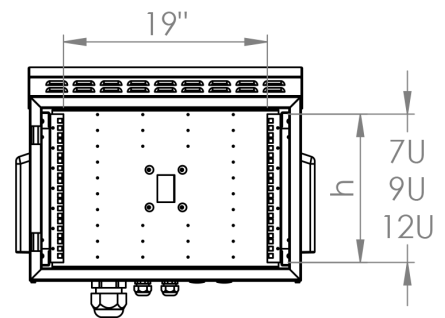

FRONT INSIDE VIEW

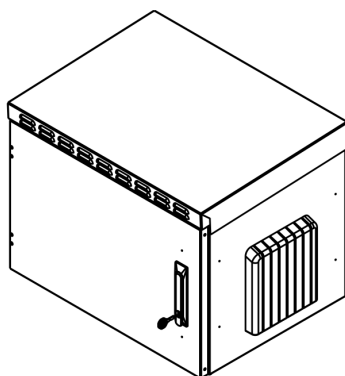

ISOMETRIC VIEW

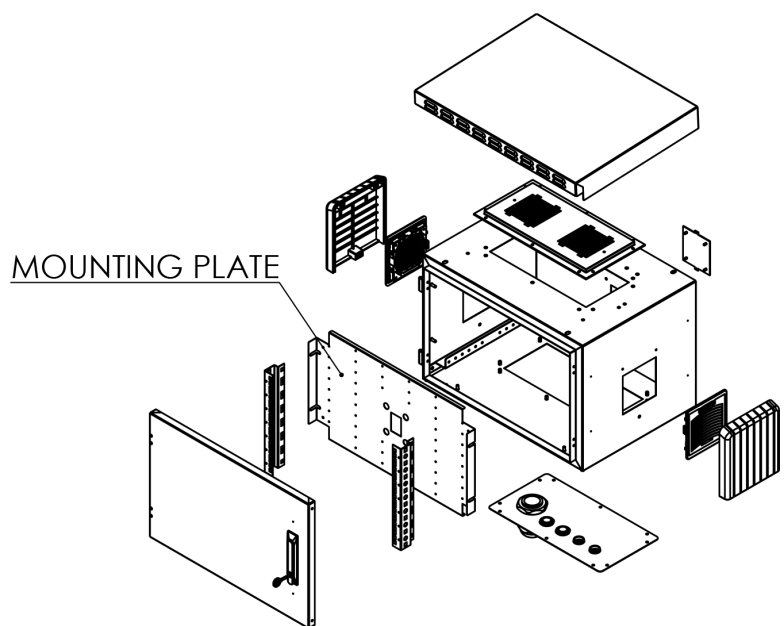

EXPLODED VIEW