

1

2

3

4

A

B

C

D

E

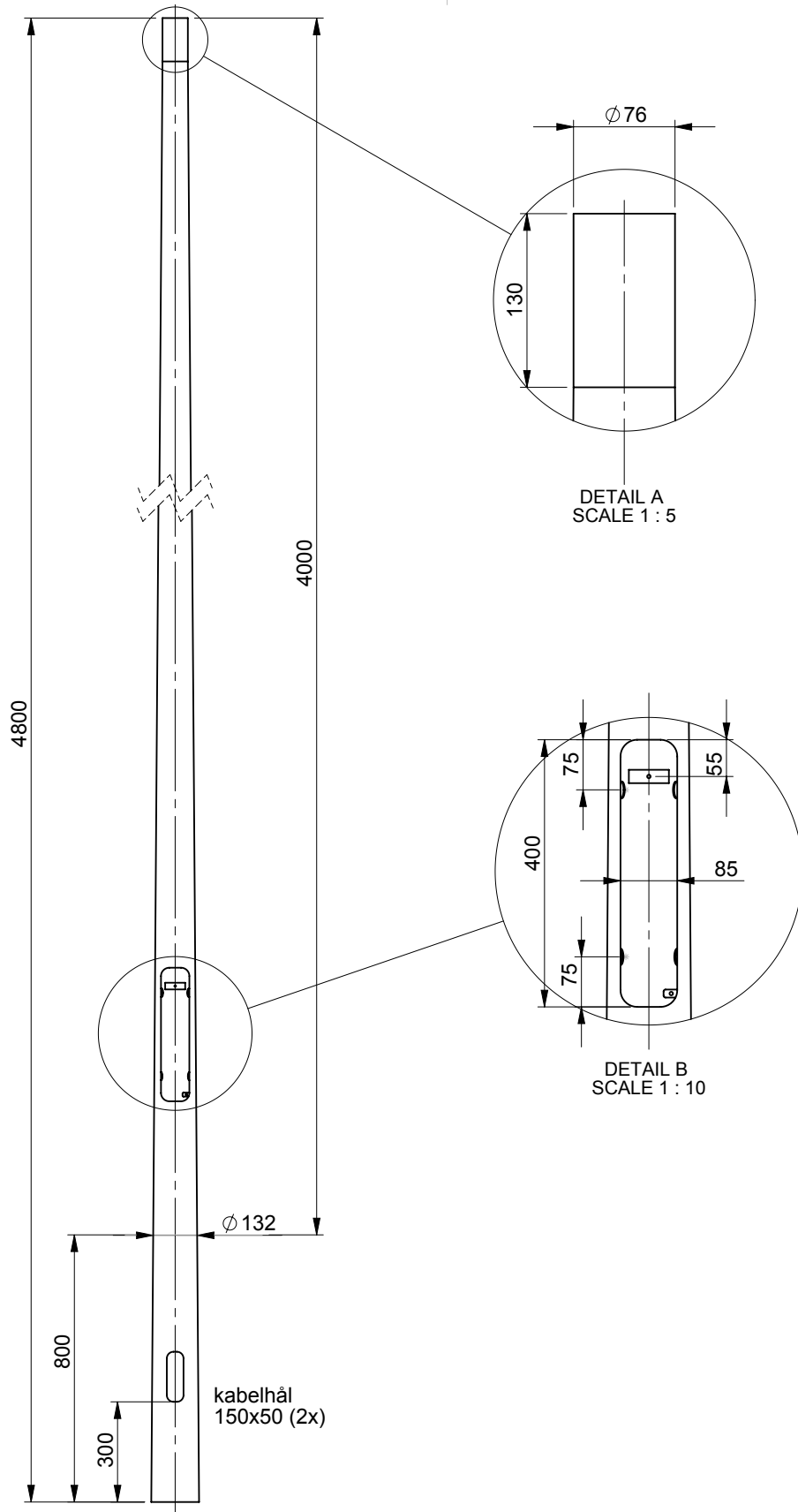

konicitet 14mm/m



Skarpa kanter brutna

Ritad av: TH	Datum: 2010-12-16	Godk. av: SA	Godk./Datum: 2012-08-23	Material:	Status: Released	Vikt: 36.32 kg	Tolerans: ISO 2768-1 c	Skala: 1:20
				Benämning: KLS 40/76-132 FL		Rev: A		Format: A4
<small>This drawing and all oppurtenant matter shall remain the company Mora Mast AB property. They shall not without our written permission, either in their original state or with any changes be copied or manifolded, shown to or in any other way communicated to or handed over to any part.</small>				Ritningsnr: 7781863				Blad: 1/1