

1

2

3

4

A

B

C

D

E

F

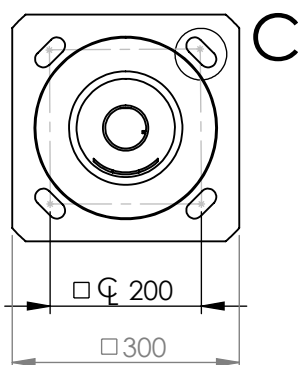
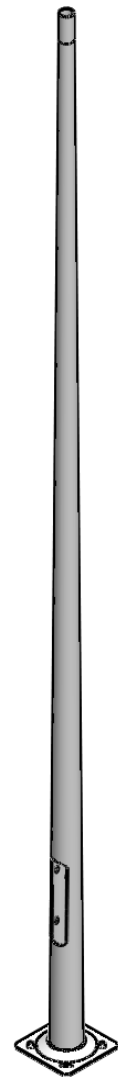
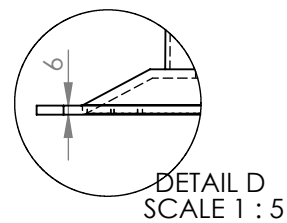
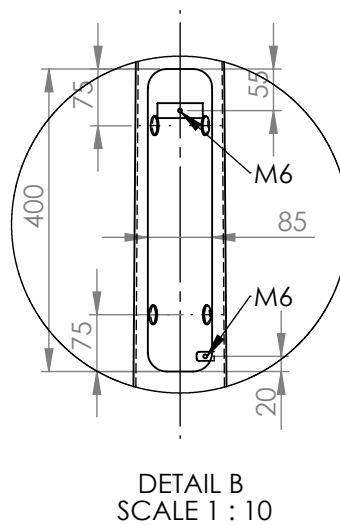
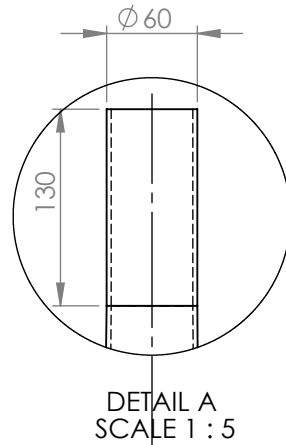
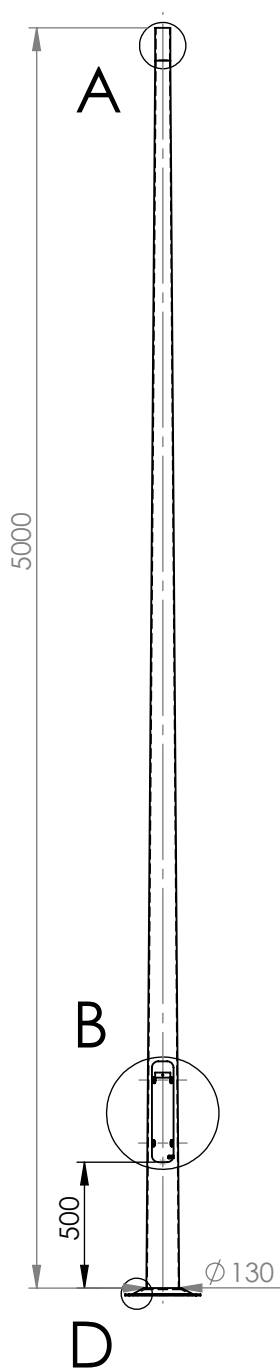
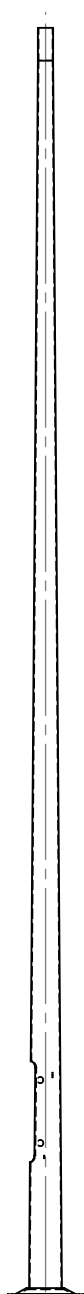

konicitet 14mm/m

Skarpa kanter brutna

Ritad av: TH	Datum: 2010-12-16	Godk. av:	Godk./Datum:	Material: S235JRG2	Status: Released	Vikt: 36.55 kg	Tolerans: ISO 2768-1 c	Skala: 1:30
-----------------	----------------------	-----------	--------------	-----------------------	---------------------	-------------------	---------------------------	----------------

 moramast

This drawing and all oppurtenant matter shall remain the company Mora Mast AB property. They shall not without our written permission, either in their original state or with any changes be copied or manifolded, shown to or in any other way communicated to or handed over to any part.

Benämning:
KLS 50/60-130 FP
Ritningsnr:
7781829

Rev:
A

Format:
A4
Blad:
1/1