

Kil och täckhuv dolda i denna vy

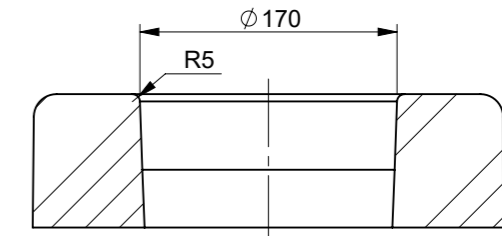

SECTION A-A
SCALE 1 : 5

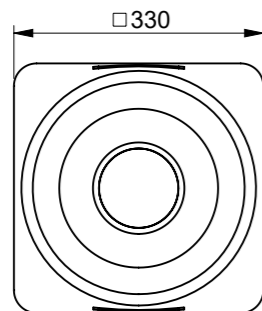
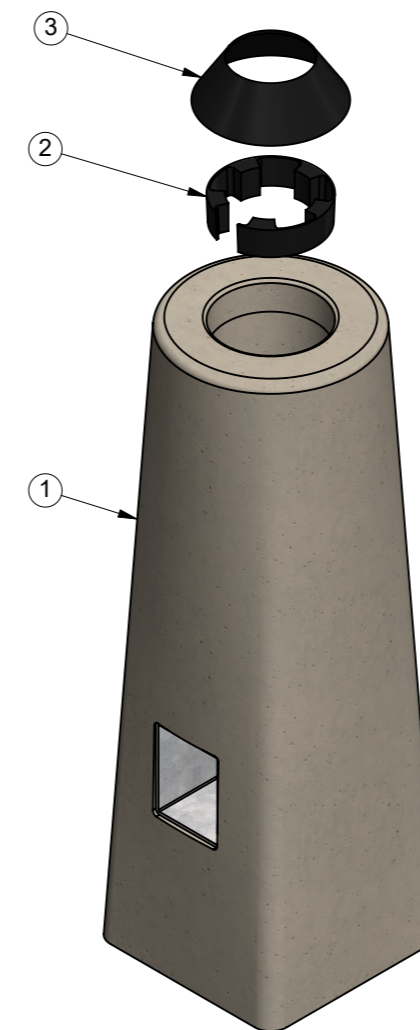

Fundamentstomme
dold i denna vy

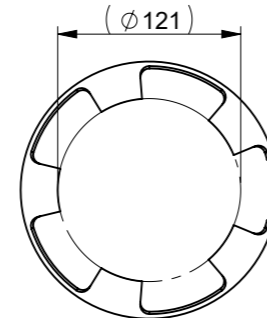

SECTION B-B
SCALE 1 : 5

- Övrig Information**
- Tillverkare: Cetong i Åstorp AB
 - E-nummer: 7780046
 - Dokumenttyp: Måttskiss (EJ tillverkningsritning)
 - Momentkapacitet: 9,3 kNm
 - Fundamentsättning: Fyllning och packning enligt AMA anläggning 17 CEB.53

No	Qty	Description	Part No
1	1	Fundamentstomme Grön 1000	003804
2	1	Låskil Ø121 Grön	003812
3	1	Täckhuv Ø121-150	003826



This drawing and all appurtenant matter shall remain the property of Mora Mast AB. They shall not be copied or reproduced in any form without our written permission, either in their original state or with any changes be copied or manufactured, shown to or in any other way communicated to or handed over to any part.

Material:	Generell tolerans:	Ritad av:	Datum:	Skala:
Benämning:		MM	2022-04-04	1:10
Insticksfundament KLS Ø121/1000		Godk. av:	Godk./Datum:	Format:
Ritningsnr:	Vikt:	BA	2022-12-07	A3
ST3160	196.35 kg	Rev:	Status:	Blad:
		A	Released	1/1