

Order No.: 5XE5D43A08DB000002 | E7728810

Product description: SL21mc,ST1.0a,4527lm740,Easy



Streetlight SL 21 micro, mast luminaire, primary light control with lens, of PMMA, primary optical cover: cover, of toughened safety glass, transparent, light distribution: ST1.0a, light emission: direct distribution, primary light characteristic: asymmetric, installation type: side-entry, post-top, LED, High Power LED, rated luminous flux: 4.527lm, luminous efficacy: 141lm/W, light colour: 740, colour temperature: 4000K, control gear: ECG dimmable, control: flexible luminous flux parameterisation, time-dependent luminous flux control, constant luminous flux control, overheat protection, mains connection: 220..240V, AC, 50/60Hz, connection cable pre-assembled, cable length: 8,5m, start of lifetime: 31,9W, end of lifetime: 33,4W, reduction: 14,9W, luminaire housing, of diecast aluminium, powder-coated, Siteco® metallic grey (DB 702S), mast flange for spigot size 60mm (post-top / side-entry) included, protection rating (complete): IP66, insulation class (complete): insulation class II (safety insulation), certification: CE, ENEC, VDE, impact resistance: IK09, permissible operating ambient temperature for outdoor applications: -40..+50°C, standard-compliant lighting for roads and squares, packaging unit: 1 piece



Lamps: LED
Wt. (kg): 4.8

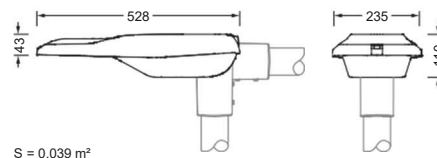

Order No.: 5XE5D43A08DB000002 | E7728810

Detailed technical description: SL21mc,ST1.0a,4527lm740,Easy



Key data

- Product type: mast luminaire
- Product name: Streetlight SL 21 micro
- Order No.: 5XE5D43A08DB000002

Lighting technology | Lamps | Control gear

Component 1

Lighting technology:

- Light control: lens of PMMA
- Cover: cover, transparent
- Light distribution: ST1.0a
- Beam angle: wide distribution
- Symmetry: asymmetric distribution
- Light emission: direct distribution

Lamps:

- Lamps: with High Power LED, LED
- Rated luminous flux: 4527lm
- Luminous efficacy: 141lm/W
- Colour temperature: 4000K
- Colour rendering index: CRI > 70
- Light colour: 740
- Rated input power begin service life: 31,9
- Rated input power end service life: 33,4
- Rated input power at 50% lumin. flux: 14,9

Operating device:

- Control gear: ECG dimmable
- Control: Easy
- Equipment: overheat protection, constant luminous flux control, time-dependent luminous flux control, flexible luminous flux parameterisation
- 50% power reduction 3 hours before / 5 hours after virtual midnight

Certificates, Standards

- Protection rating: IP66
- Insulation class: insulation class II (safety insulation)
- Impact resistance: IK09
- Temperature range (operation): -40..+50°C
- Supplement: standard-compliant lighting for roads and squares
- Corrosion protection: corrosivity category C5 according to DIN EN ISO 12944
- Certification, designation: CE, ENEC, VDE

Material, Colour

- luminaire housing: diecast aluminium, powder-coated, Siteco® metallic grey (DB 702S), please order mast flange separately, inclination adjustable: 0°, 5°, 10°, 15°, sealing non-destructively replaceable, multi-level sealing system
- Colour specification: Siteco® metallic grey (DB 702S)
- Cover: cover of toughened safety glass

Mounting

- Mounting method, mounting location: side-entry, post-top, on mast
- Mast flange Ø60mm included

Electrical connection

- Nominal voltage: 220..240V, 50/60Hz, AC
- Surge voltage resistance: 10kV 1.2/50µs
- Connection cable: pre-assembled, L= 8.5m

Dimensions, Weight

- Weight: 4.8kg
- Mast spigot: mast flange for spigot size 60mm (post-top / side-entry) included

Light emission

- Light emission: 0% at 0° inclination

Service life

- Rated service life: 100000h (L97/B10) at AT = 25°C

Order No.: 5XE5D43A08DB000002 | E7728810

Dimensions: SL21mc,ST1.0a,4527lm740,Easy

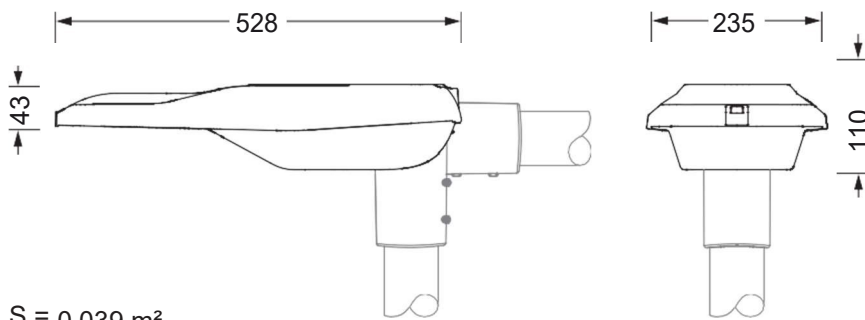

S = 0.039 m²