



DESIGNLIGHT

SCANDINAVIAN AB

DOWNLIGHT

E-NR: 74 683 00

ART NR: DB-239MW

EFFEKT POWER	MATERIAL	KELVIN	ARMATURFÄRG ARMATURE COLOR	ANSLUTNING CONNECTION	TOTAL LUMEN	USEFUL LUMEN
4,8W WITH DRIVER	ALUMINIUM	3000K	MATT WHITE	230V	400LM	384LM

CE, ROHS

350MA LED 1x3,2W
LIGHT SOURCE WATT

965 CD

Flicker Free

CRI: >80

36°

LIFETIME L70B50: 50.000H

IP20 IP44

58MM

H 37 MM

95MM

• **MULTIFUNKTION GÖR LAMPAN RIKTBAR ÅT ALLA HÅLL**

• **ANPASSAD FÖR MONTERING I BIG-BOX ELLER TAKDOSA**

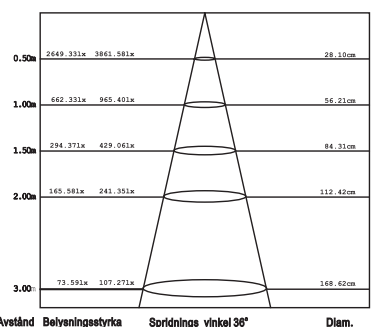
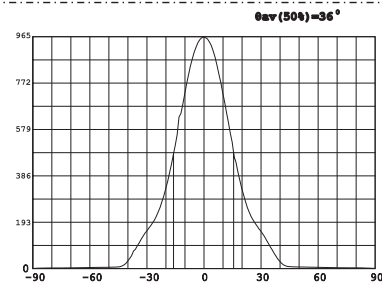
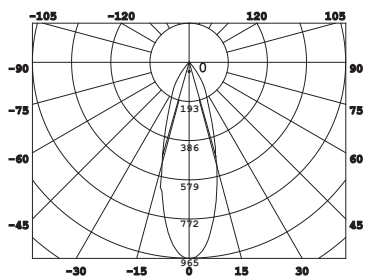

Avstånd Belysningsstyrka Spridnings vinkel 36° Diam.

1. Stäng av strömmen/Turn off the power

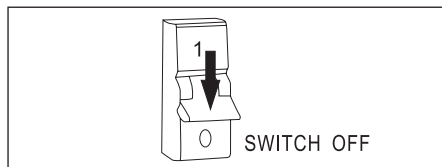

2. Borra hål i taket/Drill hole in ceiling

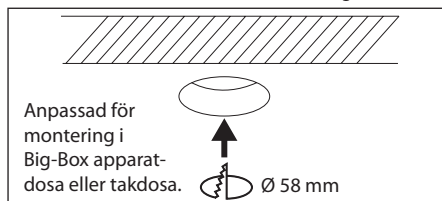

3. Anslut till LED-drivern/Connect to LED driver

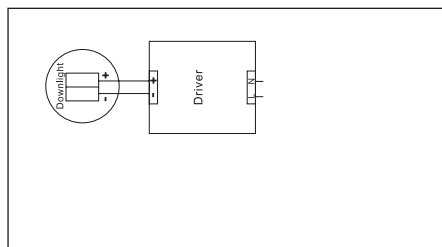

Mått/Dimension

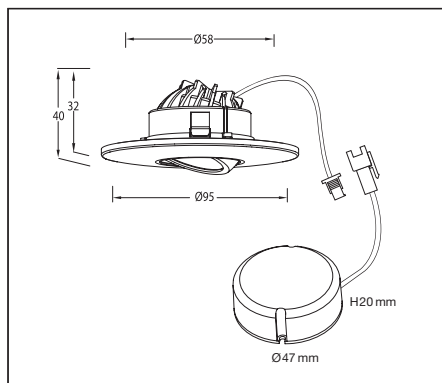

**PRODUKTEN INNEHÅLLER
LJUSKÄLLA MED
ENERGIMÄRKNING
KLASS E.**

⚠ SÄKERHET:

- Läs igenom hela manualen noggrant före installation.
- Kontrollmät ALLTID diametern före håtagning i tak.
- Förstärka dig om att spänningen är fränslagen före installation eller underhåll.
- Installation ska utföras av behörig elektriker.
- Ljuskällan är ej utbyttbar. Hela armaturen måste bytas när ljuskällan är förbrukad.

⚠ SAFETY:

- Read the entire manual carefully before installation.
- ALWAYS check the diameter before drilling holes in the ceiling.
- Make sure that the power is switched off before installation or maintenance.
- Installation must be performed by a qualified electrician.
- The light source of this luminaire is not replaceable; when the light source reaches its end of life the whole luminaire shall be replaced.



1.900K	2.700-3.000K	4.000-4.500K	4.800K	5.000-5.000K	7.000-7.500K	10.000K
STEARINLJUS CANDLE	VÄRMVIT WARM WHITE	NATURLIG VIT NATURAL WHITE	SOLLJUS DIRECT SUN	VITT DAGSLJUS DAY WHITE	KALLVIT COOL WHITE	BLÅ HIMMEL BLUE SKY

LÄS MER OM VÅRA GARANTIVILLKOR PÅ WWW.DESIGNLIGHT.NU

DESIGNLIGHT
SCANDINAVIAN AB

DESIGNLIGHT SCANDINAVIAN AB · TOFFELVÄGEN 1 · 342 60 MOHEDA
KUNDCENTER: TELEFON 0472-716 10 · FAX 0472-716 09 · INFO@DESIGNLIGHT.NU · WWW.DESIGNLIGHT.NU