

PRODUCT SPECIFICATION

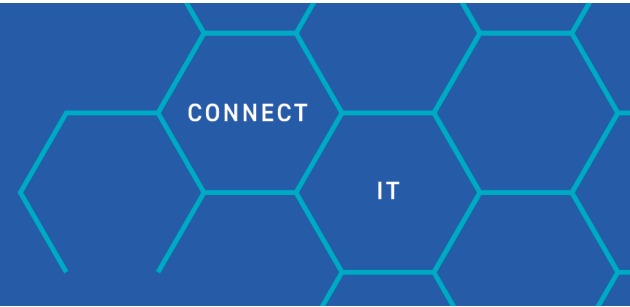

EUROLAN Wall cabinet in/outdoor IP55 600x450



Ordering information

Part number	E-number	Description
60W-SBO-07U6045-GY	2508885	Wall cabinet 7U 600x450 in/out IP55
60W-SBO-09U6045-GY	2508886	Wall cabinet 9U 600x450 in/out IP55
60W-SBO-12U6045-GY	2508887	Wall cabinet 12U 600x450 in/out IP55
60A-SBO-PLKIT-ZN	2508891	Pole assembly kit wall cabinet 4-6" p

EuroLAN IP55 indoor/outdoor enclosures are designed for industrial use. Based on EN60529 and provide IP55 protection against dust and water ingress. Where the enclosure provides IP55 protection against dust and water, with integrated fan and filter, they meet IP54.



Pole Assembly kit. Suitable for mounting wall cabinets on poles with a 4-6 diameter. Zinc plated finish.

Standards and compliances:

ISO 9001 Quality Management System

EN 61587-1

Mechanical Structures for Electronic Equipment

EN IEC 297-1, 19" Mounting

EN IEC 297-2 Overall Cabinet Dimensions

EN/IEC 60529- IP55 Ingress Protection Performance

EN/IEC 62262- IK10 Mechanical Impact Resistance

EIA/ ECA-310 (D/E) 19" 482,6 mm and U 44,45 mm Height Sizing

CE conform to:

EN 60950-1

Information Technology Equipment, Safety, Part-1: General Requirement

EN IEC 62368-1 Audio/Video, Information and Communication Technology Equipment Part 1: Safety requirements

UL listed to:

UL 2416, Outline of Investigation for Audio/Video, Information and Communication Technology Equipment Cabinet, Enclosure and Rack Systems; UL 60950-1 and CSA C22.2 NO. 60950-1-07, Information Technology Equipment Safety Part 1: General Requirements

Environment Friendly:

ISO 14001 Environmental Management System
RoHS compliancy
100% Recyclable Material

PRODUCT SPECIFICATION

CONNECT

IT

EUROLAN Wall cabinet in/outdoor IP55 600x450

Construction details:

- Integrated fan filter housings creates fresh air inlet, performing IP54 protection of water and dust ingress. With the metal cap on the fan filter housings the enclosure is protected against splashing water.
- Roof canopy provides IP54 protection once 1 or 2 fan module integrated on the ABS grill housing. Filtered openings provides efficient hot air removal from enclosure.
- Front door opening angle is up to 140 degrees. Front door has an infused sealing gasket structure which provides excellent IP protection even cold/hot weather conditions.
- Keyed swing lock handle with 3 point locking system provides security and anti-vandal structure, also maintaining the IP55 protection.
- IP55 conforming cable entry points, multiple access with 2xPG21, 1xPG48 integrated cable entry pats, 2 pcs 28 mm diameter PVC Blind cap. Which as an option can be replaced with PG21 cable entry pats. After insertion of the cables to the enclosure, it is recommended to close the openings with foam or insulation material. In addition all Eurolan wall cabinets in/outdoor are delivered with a plain metal cable entry panel which means if shipping configuration cable entry pats are not suitable for your project punching can be done on the spare cable entry plain panel.
- The front door is grounded to the main body with yellow/green 4,0 mm diameter copper wire. Front door has the strengthening bar welded inside part of the front door, 2 pcs U shaped.
- 19" rails has automated silk-screen U numbering, from top to bottom or bottom to top. To save time when installing equipment.
- 19" rails are 4 fold bending for strength 1,5 mm thickness provides the high load capacities. The 19" rails are made of steel with 8-12 micron zinc plating for corrosion resistance. 19" rails are adjustable in depth. Cabinets are delivered with 1set: 2pcs 19" front rails.
- The front door infused sealing gasket sits on the flange bends of main cabinet construction maintaining the IP rating.
- Included 4 pcs, t:3,0 mm thickness wall fixing brackets with correct screws and washers.
- A mounting plate is located at the back of the cabinet for fastening devices.
- Load capacity: 100 kg
- Color: RAL 7035 Light grey



PRODUCT SPECIFICATION

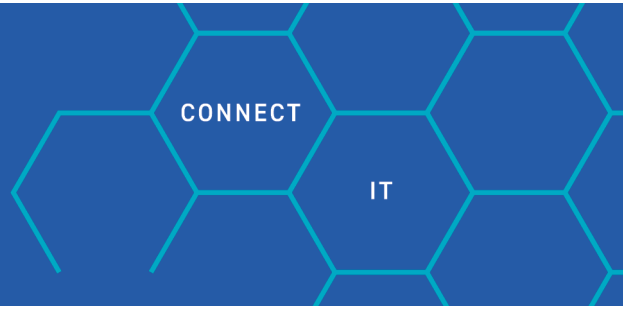

EUROLAN Wall cabinet in/outdoor IP55
600x450

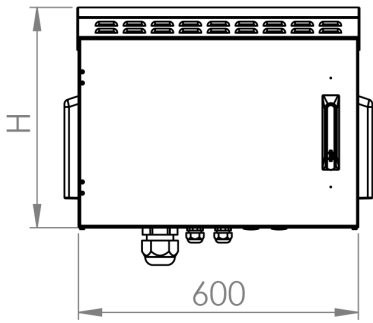

FRONT VIEW

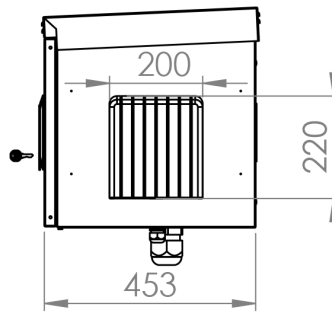

SIDE VIEW

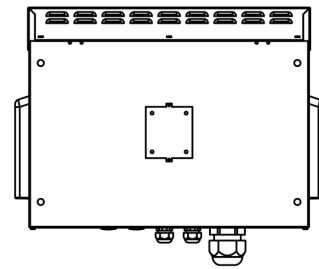

REAR VIEW



TOP VIEW

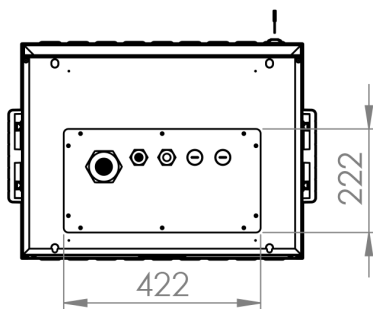

BOTTOM VIEW

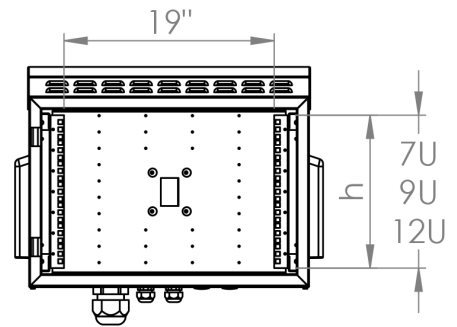

FRONT INSIDE VIEW

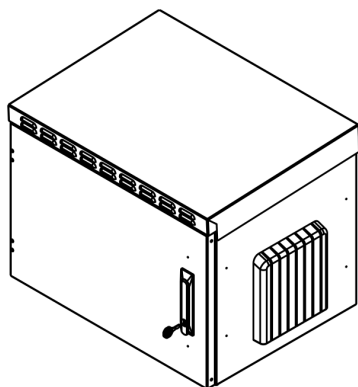

ISOMETRIC VIEW

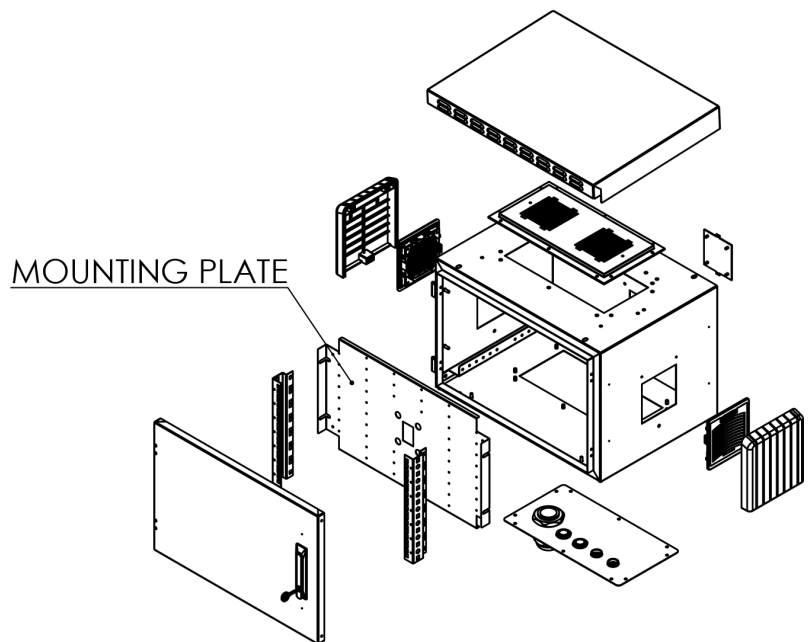

EXPLODED VIEW

PRODUCT SPECIFICATION

CONNECT

IT

EUROLAN Wall cabinet in/outdoor IP55 600x450

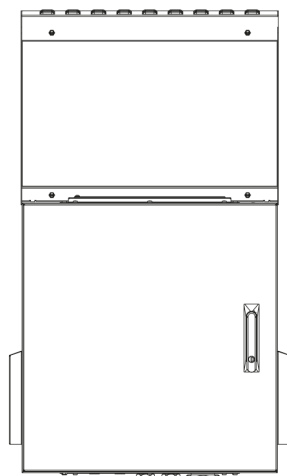

Top cover opening view

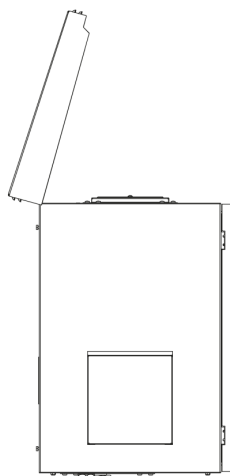

Top cover opening view side

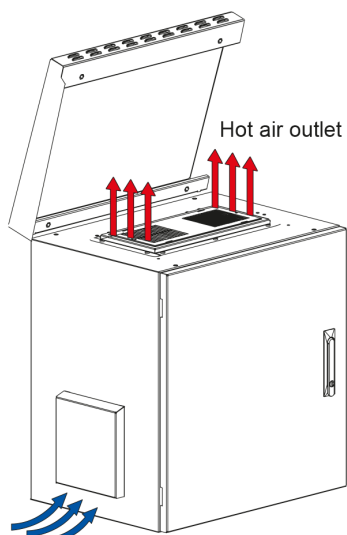
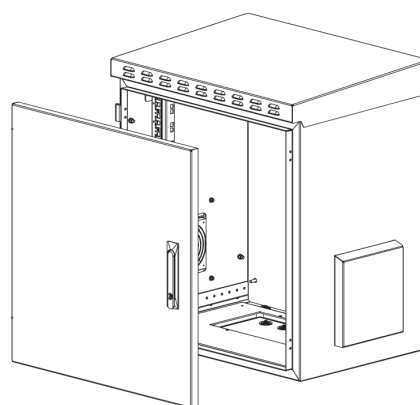

Cool air inlet

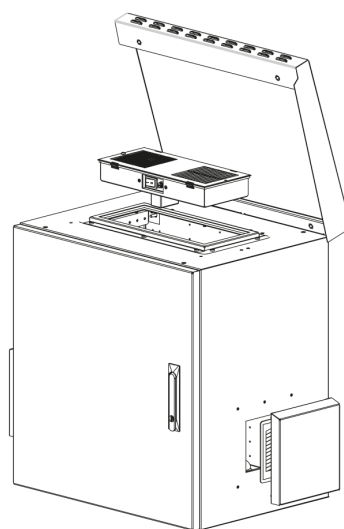

Air removal

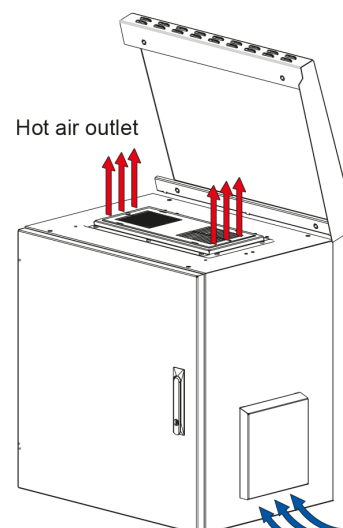

Cool air inlet

PRODUCT SPECIFICATION

CONNECT

IT

EUROLAN Wall cabinet in/outdoor IP55
600x450

