

# 2

## Snap-Action Switches

S800, S804, S814, S820 series

Changeover switches  
with double-break contacts  
and positive opening operation

Catalogue D20.en

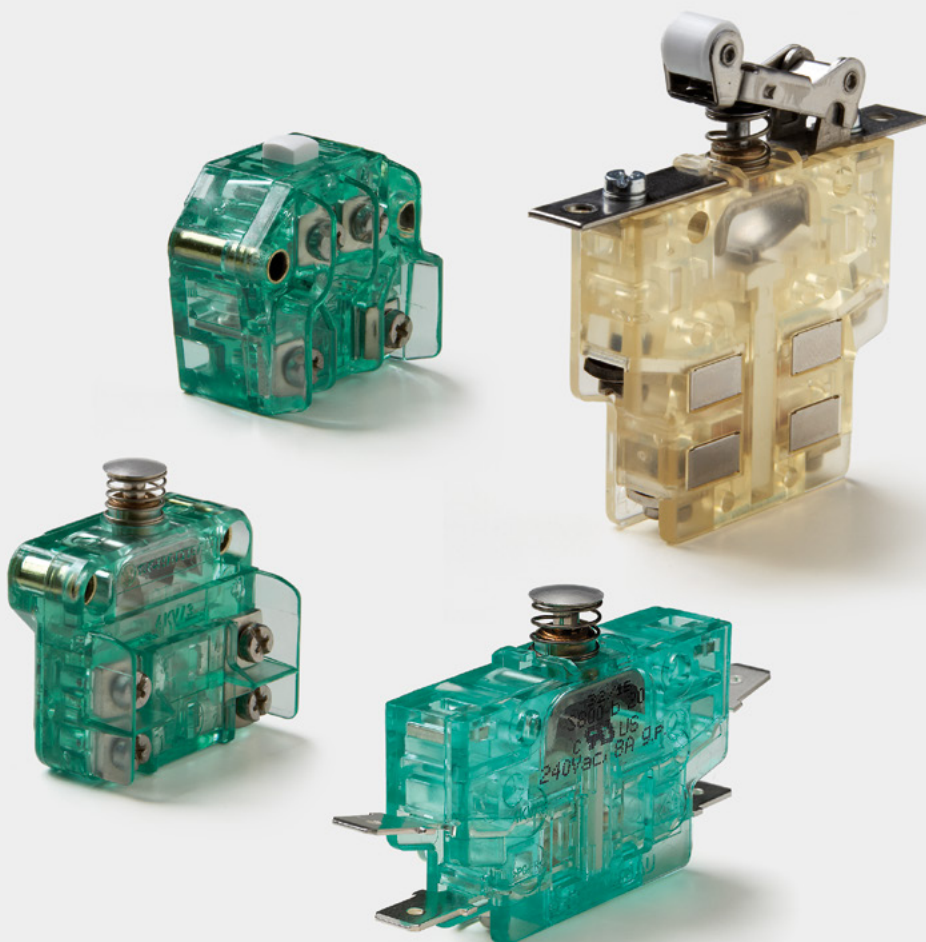

More information  
[schaltbau.com](http://schaltbau.com)

**Snap-action switches, S800, S804, S814, S820 series**

Featuring double-break contacts and positive opening operation

**S800 and S804 series – application proven snap switches**

S800 and S804 series switches feature a VDE approved positive opening operation which guarantees - within the requirements of the standard - the forced opening of contacts that have become welded together after a short-circuit. This makes them ideally suited for use in all safety related applications.

**S814 series**

The S814 has a plunger running through the switch. This makes it possible to mount two switches on top of each other, and trigger two operations with only one actuation. Wiping contacts ensure high contact reliability over the life of the switch.

**S820 – snap switches featuring higher ampacity**

S820 series switches add to the well proven standard products, offering a current-carrying capacity which is twice as high ( $I_{th} = 20 A$ ) as for example S800, as well as a more ruggedized design making them best suited for use under unfavourable ambient conditions which call for higher shock and vibration resistance. A typical field of application is medium-voltage switchgear and controlgear.

The S820 is a Form Zb SPDT-DB switch with double-break contacts. Its two mechanically linked rigid contact bridges are galvanically isolated, thus ensuring the failsafe closing of two separate load circuits with independent voltage levels.

**Features**

S800/S804/S814/S820 series



**Positive opening operation:** Reliable breaking of the normally closed (NC) circuit even if the contacts have become welded together, in compliance with IEC 60947-5-1, Annex K (except for S814).

**IP rating:** Protection against dust, hazardous substances and direct contact with live parts in compliance with IEC 60529: Contacts IP40 / Terminals IP00



**Double-break contacts:** High electrical rating due to rigid contact bridge

**Contact material:**  
S800 and S814: Silver or Gold  
S804 and S820: Silver



**Precision switch:** High switching accuracy and resistance to shock and vibration

**Blowouts:** Optional magnetic blowout to ensure efficient quenching of electric arcs and high DC switching capacity



**Design and function**

S800/S804/S814/S820 series

▶ **Actuators**

- Standard: Pushbutton
- Aux. actuator: roller lever

▶ **Mounting styles**

- Front mount
- Side mount (ganging)

▶ **Contacts**

- Double-break contacts and rigid contact bridge
- Positive opening operation
- Contact material: silver or gold

▶ **Terminals**

- M3 screws with saddle clamp
- Flat tabs 6.3x0.8
- M3 screws with spring washer

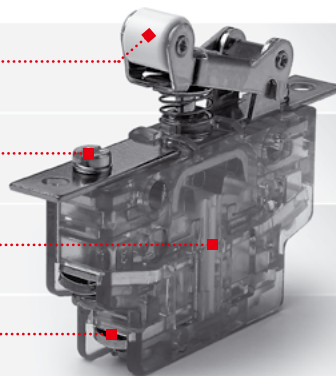

**Competence**

**The success of a product is owed to its quality**

The Schaltbau product line is clearly defined and keeps up with the technological requirements of today's markets. Behind every individual snap-action switch you will find decades of experience in engineering and manufacturing. Snap-action switches are designed with a snap-mechanism that allows fast switching, largely independent of the actuation speed. This precisely reproduces the operating position, and controls the arc more efficiently. With their well known transparent-green housing, the safety function in Schaltbau's snap-action switches is visible.

**Applications**

S800/S804/S814/S820 series

Schaltbau snap-action switches are typically used with systems and components that require a high degree of safety and reliability, such as:

- Limit switches for machine, door and plant control systems
- Aux. switches in cam gear and control and indicating devices
- Switching elements for automation
- Safety limit switches for control systems and plant controls

## Specifications

S800/S804/S814/S820 series

	Standard	S800, S804	S814	S820
Contact configuration SPDT-DB switch, contact bridge: rigid (Form Za) galvanically isolated (Form Zb) Positive opening operation Wiping action	IEC 60947	● ● --- ● ---	● ● --- ●	● --- ● ● ---
Conv. thermal current I <sub>th</sub>	IEC 60947	10 A at T = 85° C	10 A at T = 85° C	20 A at T = 85° C
Rated insulation voltage U <sub>i</sub>	IEC 60947 UL 508	400 V 300 V *1	250 V ---	400 V ---
Pollution degree	IEC 60947 UL 508	PD3 D3 *1	PD3 ---	PD3 ---
Rated impulse withstand voltage U <sub>imp</sub>	IEC 60947	4 kV	2.5 kV	4 kV
Overvoltage category	IEC 60947 UL 508	OV3 V3 *1	OV3 ---	OV3 ---
Utilization category for silver contacts *2	IEC 60947 UL 508 *1	AC-15: 230 V / 3.0 A DC-13: 110V / 1.0 A 240 V AC, 8 A general purpose	AC-15: 230 V / 1.0 A DC-13: 60V / 0.5 A ---	AC-15: 230 V / 5.0 A DC-13: 110V / 1.0 A ---
Contact gap, typ.	---	2x 1.2 mm	2x 0.4 mm	2x 2.0 mm
Contact force, typ.	---	0.35 ... 0.75 N	0.4 N	1.2 N
Contact resistance, typ.	---	100 mΩ (no leads connected)		
Positive opening force *3	IEC 60947	35 N	---	35 N
Actuator travel for positive opening	IEC 60947	S800: see page 5 S804: see page 9	---	see page 13
Maximum actuator travel *3	IEC 60947	3,2 mm	2,0 mm	4,0 mm
Actuating speed	IEC 60947	max. 1 m/s min. 1 mm/s	max. 240 mm/s min. 0,1 mm/s	max. 1 m/s min. 1 mm/s
Vibration resistance, no aux. actuator, at 1 ms max. opening time 10 ... 150 Hz 10 ... 500 Hz	IEC 60068-2-6	30g, all directions ---	20g, all directions ---	---
Shock resistance, no aux. actuator, at 1 ms max. opening time	IEC 60068-2-27	80 g, half sinus	50 g, half sinus	60 g, half sinus
Short-circuit protection for silver contacts *2	IEC 60269-2	6 A gR	---	6 A gR
Operating frequency, max.	IEC 60947	300 cycles/min	300 cycles/min	80 cycles/min
Actuating force *3 Standard / reinforced	IEC 60947	3.3 N / 5,7 N	3.2 N / 5,2 N	8 N / 18 N
Release force *3 Standard / reinforced	IEC 60947	0.2 N / 2.9 N	0.5 N / 2.0 N	1.5 N / 2.0 N
IP rating Contacts Terminals	IEC 60529		IP40 IP00	
Mechanical endurance, cycles	IEC 60947	10 million min.		1 million min.
Temperature range	IEC 60947	-40 °C ... +85 °C		
Material Contacts Terminals Housing	---	Hard silver (AgCu3) or gold (AuAg26Ni3) Brass, silver or gold plated PC, light green, transparent		Hard silver (AgCu3) Brass, silver-plated PES, amber, transparent
Mounting orientation	---		any	
Weight, no aux. actuator	---	S800: 26 g / S804: 25 g	25 g	45 g
Approvals	---			

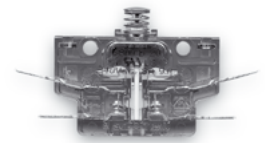

**S800 b20**  
Version with pushbutton  
(standard),  
silver contacts and  
flat tabs 6.3 x 0.8

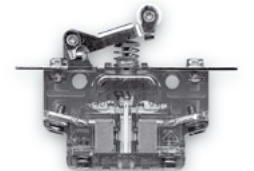

**S800 aL**  
Version with roller lever,  
mounting brackets,  
silver contacts,  
M3 screws with saddle clamp  
and blowouts

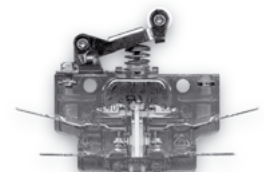

**S800 e20**  
Version with roller lever,  
silver contacts and  
flat tabs 6.3 x 0.8



**S804 b**  
Version with pushbutton  
(standard),  
silver contacts and  
M3 screws with saddle clamp



**S814 b**  
Version with pushbutton  
(standard),  
silver contacts and  
M3 screws with saddle clamp

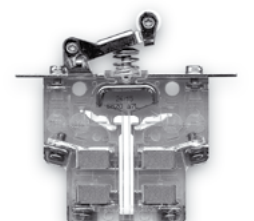

**S820 a7**  
Version with roller lever,  
mounting brackets,  
silver contacts and  
M3 screws with saddle clamp

\*1 S800 only

\*2 S800, S814 only: data for gold contacts on request

\*3 Measured next to actuator



**Note:**  
Data valid for new switches under laboratory conditions  
and at room temperature, unless otherwise mentioned.

**S800** Ordering code, Accessories

S800 series

• **Ordering code**

Example: **S800 b10/20/40 L**

<b>Series, contact configuration</b>		<b>Special designs, optional</b>	
S800	Form Za SPDT-DB switch with positive opening operation and rigid contact bridge	Blowouts	L
<b>Actuator and mounting styles</b>		<b>Actuating and release forces</b>	
	<b>Actuator</b>	<b>Standard</b>	*
	<b>Front mount</b>	<b>Stronger reset spring</b>	40
b	Pushbutton	M3 screws with saddle clamp	
c	Pushbutton	Flat tabs 6.3x0.8	
e	Roller lever	<b>Terminals</b>	
a	Roller lever	*	
as	Roller lever	20	
d	Roller lever		
<b>Contact material</b>			
*	Silver		
10	Gold		

• **Accessories**

- SK-100 Protective housing (half shells) made of PA6
- SK-200 Protective cover made of flexible soft PVC
- SK-400 Protective cap made of glass fibre reinforced PC



**Note:**  
This catalogue shows only stock items. For some variants minimum quantities apply. Please ask for the conditions.

**Special variant:**

If you need a special variant of the switch, please do not hesitate to contact us. Maybe the type of switch you are looking for is among our many special designs. If not, we can also supply customized designs. In this case minimum quantities apply.

\* No index

Parameter	Code	Version
IP rating: contacts / terminals		IP40/20
<b>Actuator styles</b>		
▶ Pushbutton (standard) No mounting brackets	b	
▶ Pushbutton with mounting brackets	c	
▶ Roller lever No mounting brackets	e	
▶ Roller lever with mounting brackets	a	
▶ Roller lever with mounting brackets, slotted holes	as	
▶ Roller lever with mounting brackets, angled on one end	d	
▶ Series	S800	
▶ Contact material	* / 10	
▶ Actuating and release force	* / 40	
▶ Blowouts (special design)	L	
<b>Terminal styles</b>		
▶ M3 screws with saddle clamp	--- *	
▶ Flat tabs 6.3x0.8	20	

**Dimension and circuit diagrams**

S800 series

- Dimensions S800 b Form Za SPDT-DB switch

**Circuit diagram**

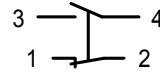
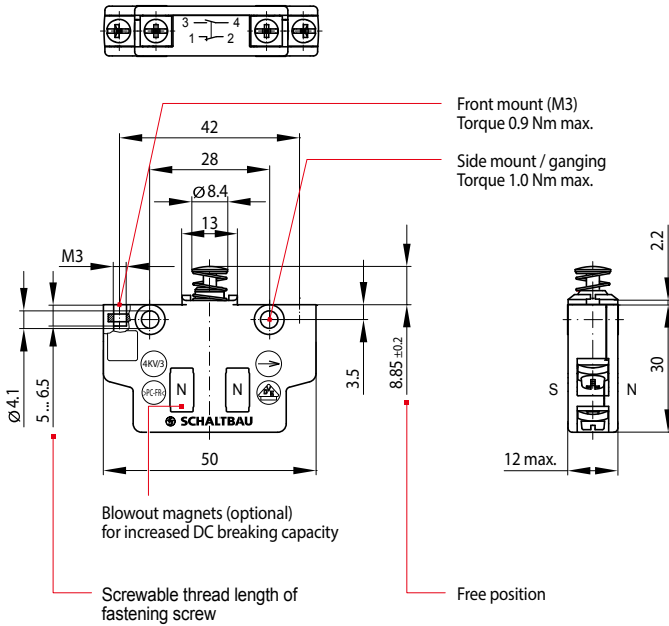

**S800**

Form Za SPDT-DB switch with positive opening operation, silver or gold contacts and rigid contact bridge

S800 **b** Pushbutton (standard)

**Actuator styles and positions**

S800 series

- S800 Pushbutton (standard) **b** / **c**

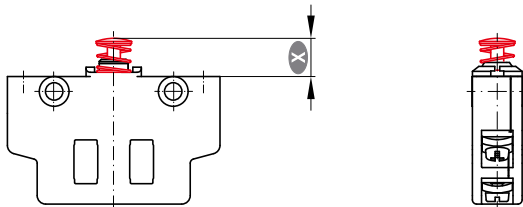

Actuator positions	Pushbutton (standard) <b>b</b> / <b>c</b> Dimension $\varnothing$ in mm
Free position	8.85 ± 0.20
Operating position	6.60 ± 0.35
Release position	7.80 ± 0.35
Total positive opening travel	5.85
Total travel position	5.65
Movement differential (between operating and release position)	1.2 (typical)

**⚠ Note:** To ensure proper operation of the positive opening function it is necessary to depress the plunger to the point of total positive opening travel. However, it must not be pushed beyond total travel position. Data is valid for new switches.

- S800 Roller lever **e** / **a** / **as** / **d**

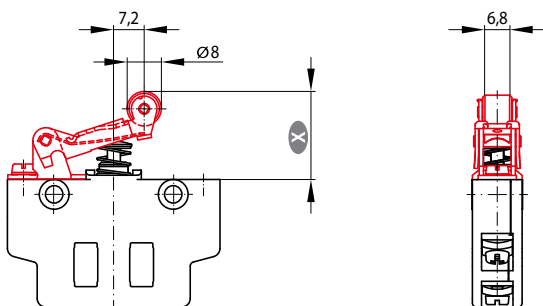

Actuator positions	Roller lever <b>e</b> / <b>a</b> / <b>as</b> / <b>d</b> Dimension $\varnothing$ in mm
Free position	20.25 ± 0.35
Operating position	16.60 ± 0.50
Release position	18.40 ± 0.50
Total positive opening travel	13.6
Total travel position	13.3
Movement differential (between operating and release position)	1.8 (typical)

**⚠ Note:** To ensure proper operation of the positive opening function it is necessary to depress the plunger to the point of total positive opening travel. However, it must not be pushed beyond total travel position. Data is valid for new switches.

**Mechanical fastening** Front mount, ganging

S800 series

**Front mount**

- **No mounting brackets:** By way of the nut retainers (M3) that are inserted into the switch housing. Torque 0.9 Nm max.
- **With mounting brackets:** By way of M3 screws for all actuator styles. Torque 0.9 Nm max.

**Actuators without mounting brackets**

- **Pushbutton (standard) style [b]**

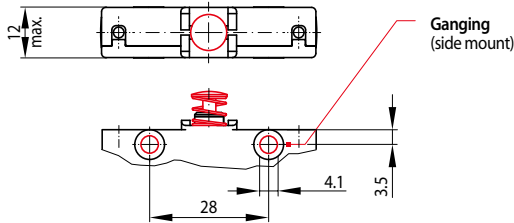
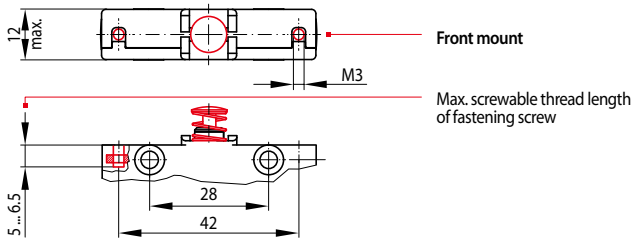

- **Roller lever style [e]**

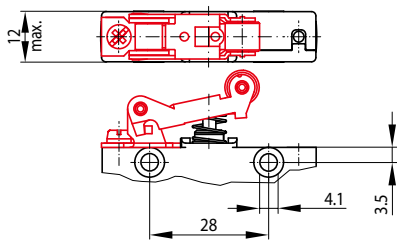

**Ganging**

- Through the transversal bore holes with 4 mm screws or bolts. Torque 1.0 Nm max.
- Alternatively DUO clips or retaining rings can be used.

**Actuators with mounting brackets**

- **Pushbutton style [c]**

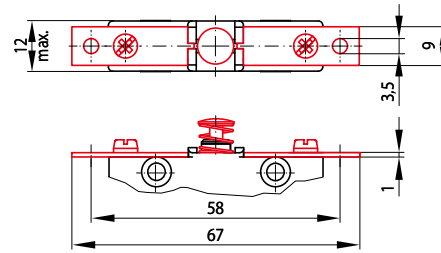

- **Roller lever style [a]**

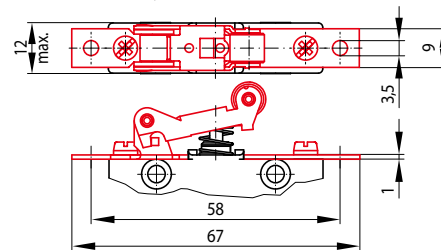

- **Roller lever style [as]**

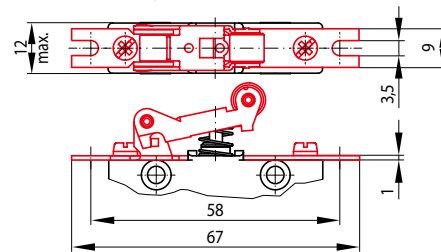

- **Roller lever style [d]**

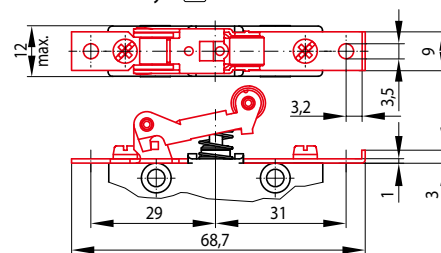

**Terminal styles** M3 screws, flat tabs 6.3x0.8

S800 series

- **M3 screws with saddle clamp (standard) style [19]**

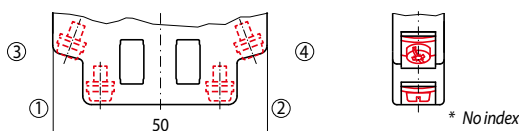

- **Flat tabs 6.3x0.8 style [20]**

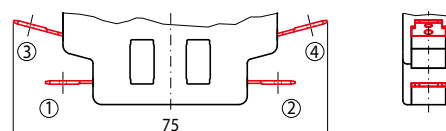

- Note:**
- Single and multiple-wire conductors with wire gauges AWG 18... 12 (0.75 mm<sup>2</sup> ... 2.5 mm<sup>2</sup>) can be clamped without wire end ferrules. If a ferrule is used the maximum wire gauge is AWG 14 (1.5 mm<sup>2</sup> max.)
  - Max. 2 conductors with the same wire gauge can be clamped per terminal.
  - Tightening torque of terminal screws should be 0.9 Nm max.
  - IP rating: contacts IP00 / terminals IP40

**Instruction** on when to use a roller lever (examples)

S800 series

Snap-action switches are designed for actuation with and without roller lever. A roller lever is required, if the direction of actuation deviates more than  $\pm 15^\circ$  from the perpendicular line.

• Switch with roller lever actuated by cam disk

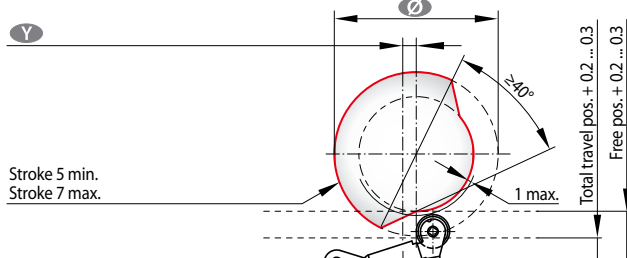

Cam disk Ø	Clearance Y
40 mm	3.6 mm
60 mm	0 mm
100 mm (max.)	0 mm

• Switch with roller lever actuated by trigger cam

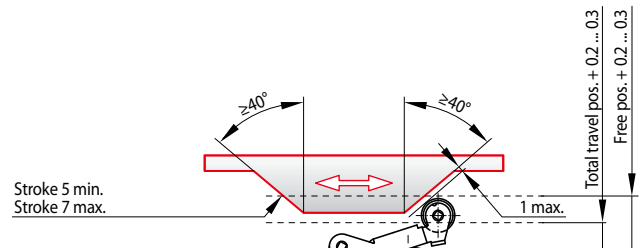

**Protective housing** SK-100, SK-200, SK-400, SK-400-B

S800 series

**SK-100**

Protective housing (half shells) made of fibre glass reinforced PC. Screw-type terminals of switches used with protective housing SK-100 are sealed to IP40.

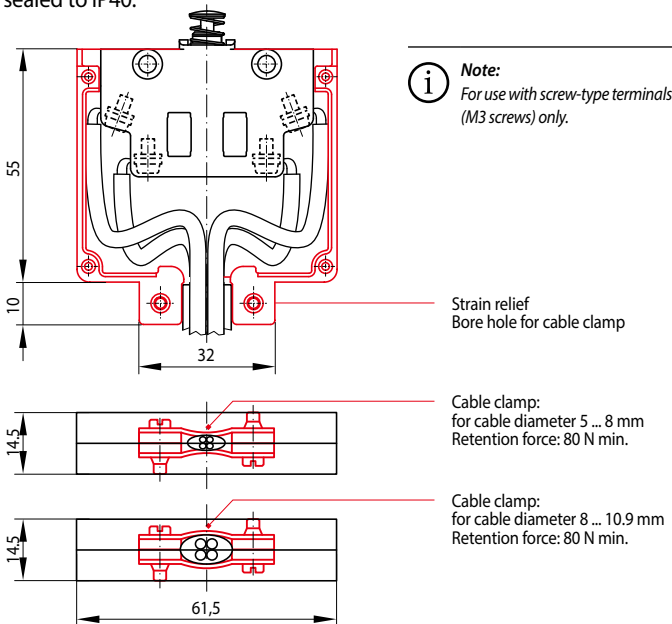

**SK-200**

Protective cover made of flexible soft PVC. Protective cover SK-200 prevents accidental contact with the 4 live M3 screw terminals.

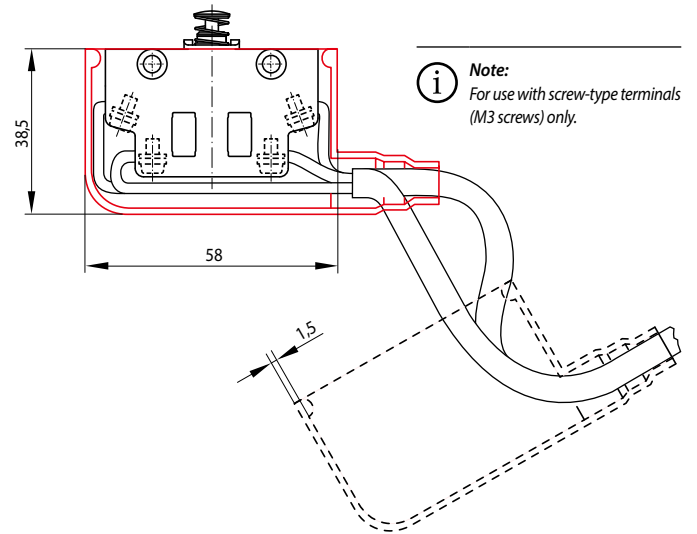

**SK-400**

Protective cap made of fibre glass reinforced PC. Protective cap SK-400 prevents accidental contact with the 4 live M3 screw terminals.

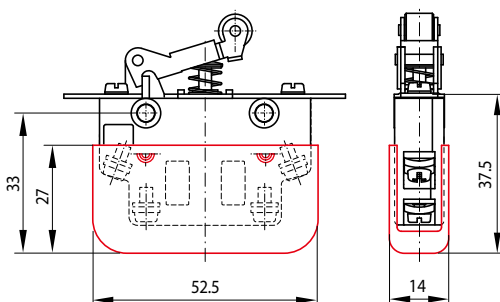

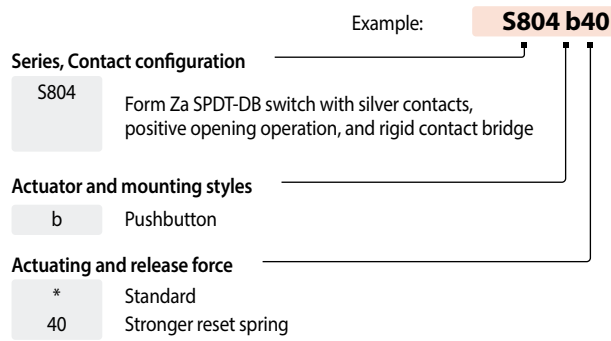

**Protective caps** Protective cap SK100, SK200 and SK400, from left to right



**Note:**  
This catalogue shows only stock items. For some variants minimum quantities apply. Please ask for the conditions.

**Special variant:**  
If you need a special variant of the switch, please do not hesitate to contact us. Maybe the type of switch you are looking for is among our many special designs. If not, we can also supply customized designs. In this case minimum quantities apply.

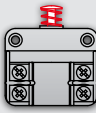
\* No index

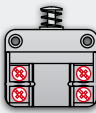
Parameter	Code	Version
IP rating: contacts / terminals		IP40/20
<b>Actuator style</b>		
▶ Pushbutton (standard)	b	
▶ Series ▶ Actuating and release force	S804 */40	
<b>Terminal style</b>		
▶ M3 screws with saddle clamp	---*	

**Dimension and circuit diagrams**

S804 series

- **Dimensions S804 b** Form Za SPDT-DB switch

**Circuit diagram**

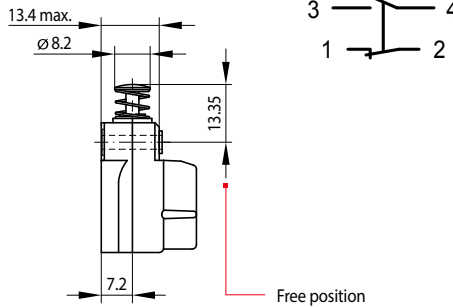
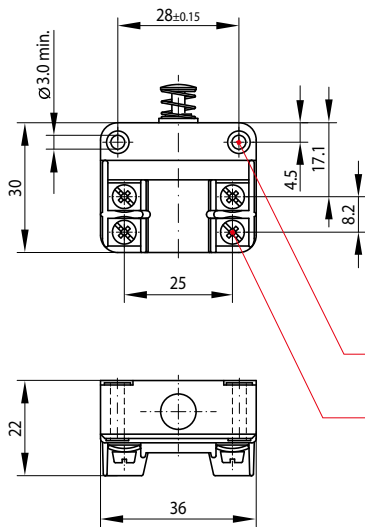

Mount / ganging  
Torque 1.0 Nm max.

Terminal screws  
M3 with saddle clamp  
Torque 0.9 Nm max.



**Note:**

- Single and multiple-wire conductors with wire gauges AWG 18 ... 12 (0.75 mm<sup>2</sup> ... 2.5 mm<sup>2</sup>) can be clamped without wire end ferrules. If a ferrule is used the maximum wire gauge is AWG 14 (1.5 mm<sup>2</sup> max.)
- Max. 2 conductors with the same wire gauge can be clamped per terminal
- IP rating: contacts IP00 / terminals IP40



**S804**

Form Za SPDT-DB switch with positive opening operation, silver contacts and rigid contact bridge

S804 **b** Pushbutton (standard)

**Actuator styles and positions**

S804 series

- **S804 Pushbutton (standard) **b****

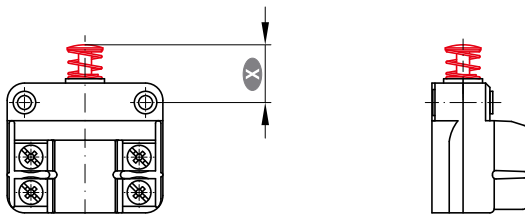

Actuator positions	Pushbutton (standard) <b>b</b> Dimension <b>X</b> in mm
Free position	13.35 ± 0.15
Operating position	11.10 ± 0.35
Release position	12.30 ± 0.35
Total positive opening travel	10.35
Total travel position	10.15
Movement differential (between operating and release position)	1.2 (typical)



**Note:** To ensure proper operation of the positive opening function it is necessary to depress the plunger to the point of total positive opening travel. However, it must not be pushed beyond total travel position. Data is valid for new switches.

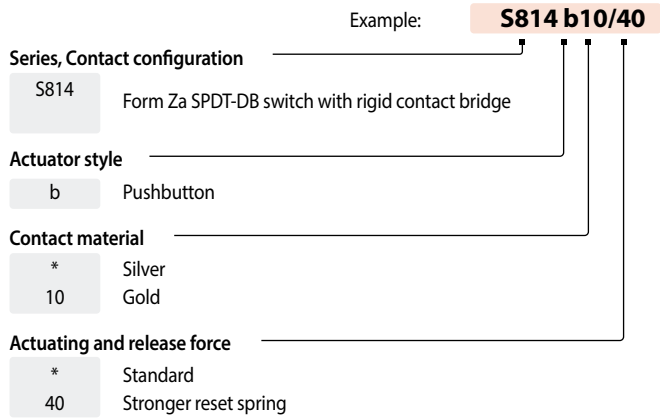

**Note:**  
This catalogue shows only stock items. For some variants minimum quantities apply. Please ask for the conditions.

**Special variant:**  
If you need a special variant of the switch, please do not hesitate to contact us. Maybe the type of switch you are looking for is among our many special designs. If not, we can also supply customized designs. In this case minimum quantities apply.

\* No index

Parameter	Code	Version
IP rating: contacts / terminals		IP40/20
<b>Actuator style</b>		
▶ Pushbutton (standard)	b	
▶ Series ▶ Contact material ▶ Actuating and release force	S814 */10 */40	
<b>Terminal style</b>		
▶ M3 screws with saddle clamp	---*	

**Dimension and circuit diagrams**

S814 series

• **Dimensions S814 b** Form Za SPDT-DB switch

**Circuit diagram**

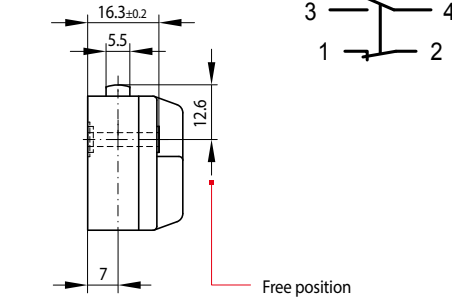
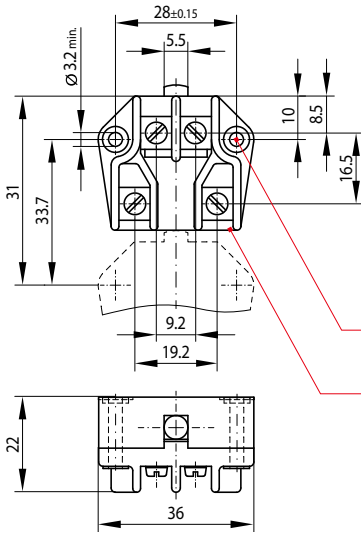

Mount / ganging  
Torque 1.0 Nm max.

Terminal screws  
M3 with saddle clamp  
Torque 0.9 Nm max.

- Note:**
- Single and multiple-wire conductors with wire gauges AWG 18 ... 12 (0.75 mm<sup>2</sup> ... 2.5 mm<sup>2</sup>) can be clamped without wire end ferrules. If a ferrule is used the maximum wire gauge is AWG 14 (1.5 mm<sup>2</sup> max.)
  - Max. 2 conductors with the same wire gauge can be clamped per terminal
  - IP rating: contacts IP00 / terminals IP40

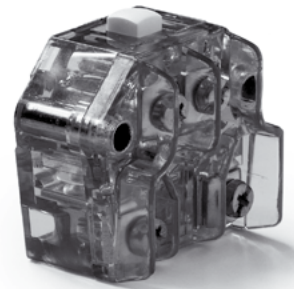

**S814**

Form Za SPDT-DB switch with silver or gold contacts, rigid contact bridge and wiping action

S814 **b** Pushbutton (standard)

**Plunger travelling full length through the switch**

S814 series

A special feature of the S814 is its plunger which, on actuation travels the full-length of the switch. This makes them ideally suited for applications where the switching element must be in line with the perpendicular line of actuation. It is thereby possible to mount two S814 switches on top of each other and trigger two switching operations with only one actuation, like a full-blown dual changeover switch.

For this reason they are especially suited for use as emitter switches for meters and counters, for use with indicating devices, master controllers and control units and, last but not least, as switching elements for membrane switches.

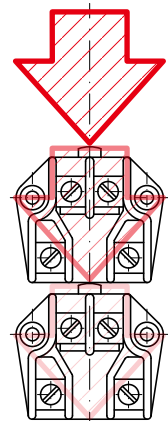

**Actuator styles and positions**

S814 series

• **S814 Pushbutton (standard) b**

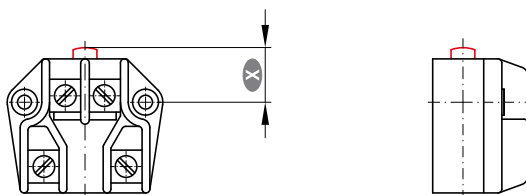

Actuator positions	Pushbutton (standard) <b>b</b> Dimension <b>X</b> in mm
Free position	12.6 ± 0.2
Operating position	11.6 ± 0.2
Release position	12.1 ± 0.2
Total travel position	10.6
Movement differential (between operating and release position)	0.5 (typical)

**Note:**  
Actuator must not be pushed beyond total travel position.  
Data is valid for new switches..

**S820** Ordering code

S820 series

Example: **S820 b7/40 L**

**Series, Contact configuration**

**S820** Form Zb SPDT-DB with positive opening operation and galvanically isolated contact bridges

**Actuator styles**

	Actuator style	Mounting style
b	Pushbutton	No mounting brackets
e	Roller lever	No mounting brackets
a	Roller lever	With mounting brackets

**Contact material**

**7** Silver (Fixed contact AgCu3 / contact bridge AgSnO2)

**Special design, optional**

Blowouts **L**

**Actuating and release force**

Standard \*  
Stronger reset spring 40



**Note:**

This catalogue shows only stock items. For some variants minimum quantities apply. Please ask for the conditions.

**Special variant:**

If you need a special variant of the switch, please do not hesitate to contact us. Maybe the type of switch you are looking for is among our many special designs. If not, we can also supply customized designs. In this case minimum quantities apply.

\* No index

Parameter	Code	Version
IP rating: contacts / terminals		IP40/20
<b>Actuator styles</b>		
▶ Pushbutton (standard), no mounting brackets	b	
▶ Roller lever, no mounting brackets	e	
▶ Roller lever, with mounting brackets	a	
▶ Series ▶ Contact material ▶ Actuating and release force ▶ Blowouts (special design)	S820 7 40 L	
<b>Terminal style</b>		
▶ M3 screws with saddle clamp	--- *	

**Dimension and circuit diagrams**

S820 series

• **Dimensions S820 b Form Zb SPDT**

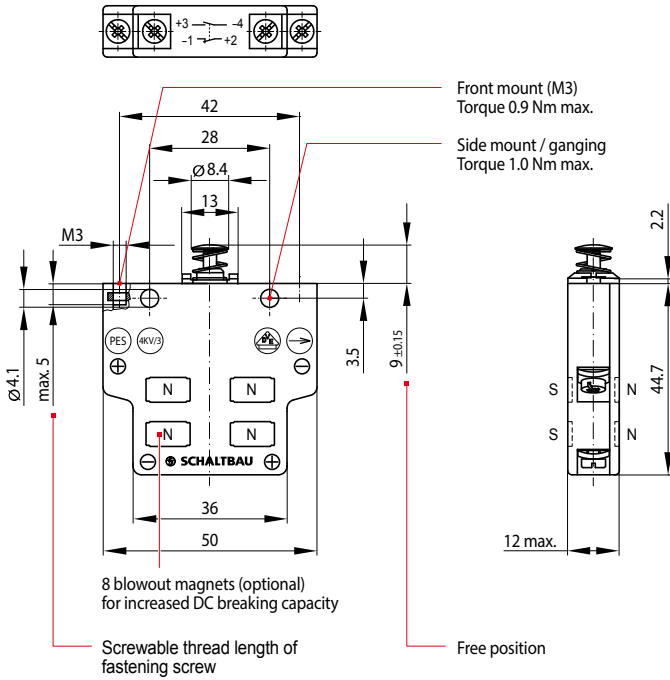

**Circuit diagram**

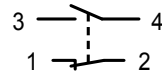

**S820**

Form Zb SPDT-DB with silver contacts, positive opening operation and galvanically isolated contact bridges

S820 **b** Pushbutton (standard)

**Actuator styles and positions**

S820 series

• **S820 Pushbutton (standard) **b****

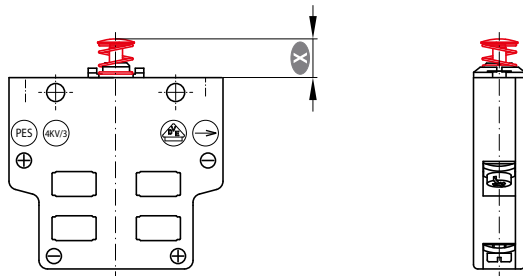

Actuator positions	Pushbutton (standard) <b>b</b> Dimension $\otimes$ in mm
Free position	9.0 ± 0.15
Operating position	6.0 ± 0.35
Release position	8.0 ± 0.35
Total positive opening travel	5.2
Total travel position	5.0
Movement differential (between operating and release position)	2.0 (typical)



**Note:** To ensure proper operation of the positive opening function it is necessary to depress the plunger to the point of total positive opening travel. However, it must not be pushed beyond total travel position. Data is valid for new switches.

• **S820 Roller lever **e**, **a****

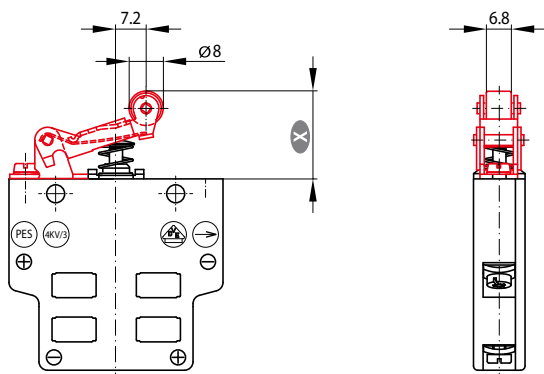

Actuator positions	Roller lever <b>e</b> , <b>a</b> Dimension $\otimes$ in mm
Free position	20.4 ± 0.35
Operating position	15.6 ± 0.5
Release position	18.85 ± 0.5
Total positive opening travel	13.1
Total travel position	12.9
Movement differential (between operating and release position)	3.25 (typical)



**Note:** To ensure proper operation of the positive opening function it is necessary to depress the plunger to the point of total positive opening travel. However, it must not be pushed beyond total travel position. Data is valid for new switches.

**Mechanical fastening** Front mount, ganging

S820 series

**Front mount**

- **No mounting brackets:** By way of the nut retainers (M3) that are inserted in the housing of the switch. Torque 0.9 Nm max.
- **With mounting brackets:** By way of M3 screws for all actuator styles. Torque 0.9 Nm max.

**Actuators without mounting brackets**

- **Pushbutton (standard) no mounting brackets style [b]**

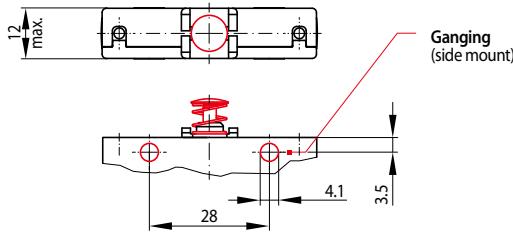
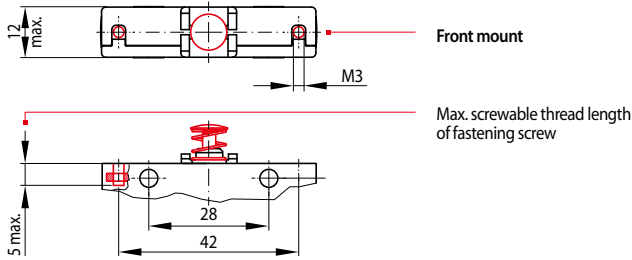

- **Roller lever without mounting brackets style [e]**

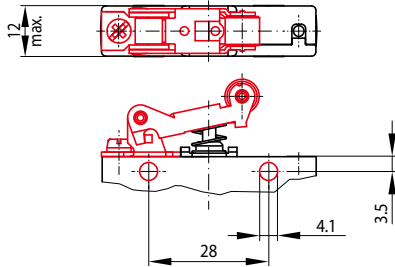

**Ganging**

- Through the transversal bore holes with 4 mm screws or bolts. Torque 1.0 Nm max.
- Alternatively DUO clips or retaining rings can be used.

**Actuators with mounting brackets**

- **Roller lever with mounting brackets style [a]**

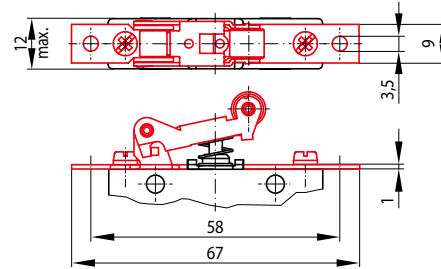

**Terminal style** M3 screws

S820 series

- **M3 screws with saddle clamp (standard) style [\*]**

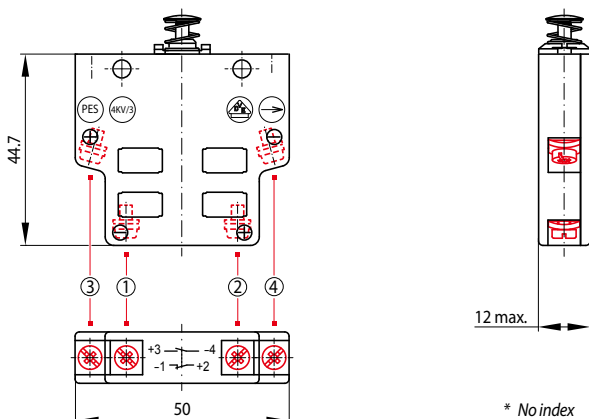

- Note:**
- Single and multiple-wire conductors with wire gauges AWG 18... 12 (0.75 mm<sup>2</sup>... 2.5 mm<sup>2</sup>) can be clamped without wire end ferrules. If a ferrule is used the maximum wire gauge is AWG 14 (1.5 mm<sup>2</sup> max.)
  - Max. 2 conductors with the same wire gauge can be clamped per terminal.
  - Tightening torque of terminal screws should be 0.9 Nm max.
  - IP rating: contacts IP00 / terminals IP40

## Instruction on when to use a roller lever (examples)

Snap-action switches are designed for actuation with and without roller lever. A roller lever is required, if the direction of actuation deviates more than  $\pm 15^\circ$  from the perpendicular line.

### Switch with roller lever actuated by cam disk

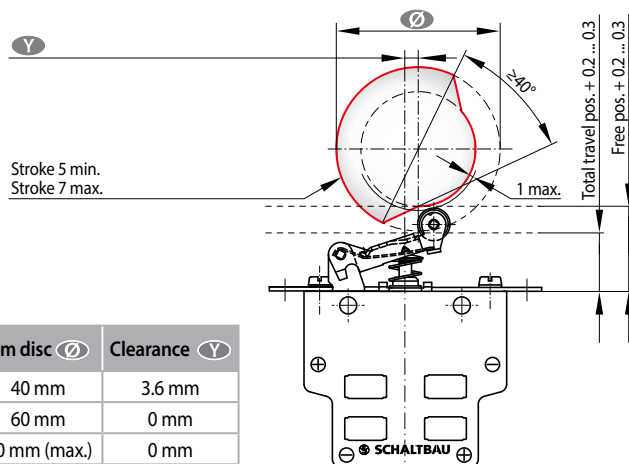

### Switch with roller lever actuated by trigger cam

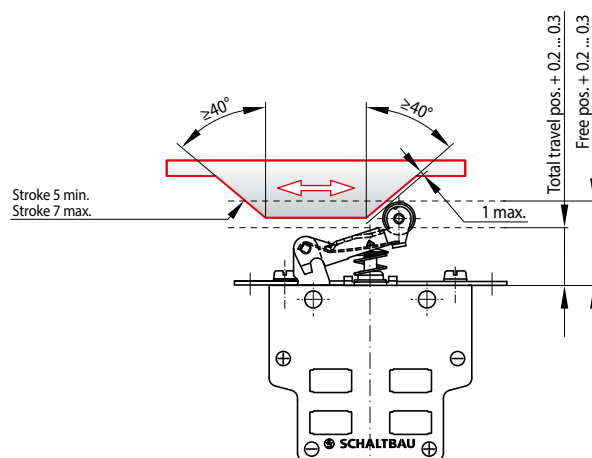

## Mounting and safety instructions, environmental conditions, standards

### Mounting instructions:

- Snap-action switches should be mounted by qualified professional staff only.
- Observe the required clearance and creepage distances. This is also true for connected wires.
- It is necessary to use insulating plates when ganging or mounting switches on uninsulated surfaces.
- The switches can be mounted in any desired position.
- When mounting the switches mechanically make sure to have 2 fastening elements (e.g. screws).
- Only use adequate fastening elements such as cylinder head or collar screws or DUO-clips, including washers. When fastening make sure not to exceed the maximum tightening torque.
- When mounting switches with mounting brackets make sure that the mounting surface is level.
- Avoid tilting the screw when mounting and prevent mechanical tension on the housing.
- The actuator may not be pre-tensioned when in the free position. When actuated, the actuator should travel well beyond the operating position, for at least 50% of the predefined overtravel, all the way to total travel position.
- To ensure the proper function of the positive opening operation it is necessary to depress the plunger to the total travel position.
- To prevent mechanical destruction of the switch, make sure that actuation of the switch does not exceed the specified total travel position. Avoid using the switch as a mechanical end stop.
- High-impact actuation of the switch can also have a negative effect on its mechanical life.
- When securing stripped wire ends in the terminal clamp, make sure the wire insulation is flush with the clamp.
- Make sure that strain relief of the connected leads functions.
- Prevent a transfer of forces to the switch terminals.
- When using versions with blowout magnets observe the right polarity, see circuit diagram at the bottom of the switch.

### Non-permissible environmental conditions:

- Cleaning agents, adhesives, solvents, or screw-retaining varnish must be compatible with polycarbonate (S800, S804, S814 series) and polyethersulfone (S820 series), respectively. Never use chemicals not compatible with polycarbonate for S800, S804 and S814 series switches and polyethersulfone for S820 series switches, respectively.
- Using chemicals which are not compatible can result in cracks, deformation, breakage and dissolution of the housing or complete destruction of the switch.

### Safety instructions:

- Be sure to make visual inspections regularly.
- Improper handling of the switch, e. g. when hitting the floor with some impact, can result in breakage, visible cracks and deformation.
- The switch suitability has to be confirmed by the customer for the specific application, and under application conditions.



**Defective parts must be replaced immediately!**



**For detailed maintenance, safety and mounting instructions please refer to our operating manuals:**

➔ [schaltbau.info/safety2en!](https://schaltbau.info/safety2en!)

### Standards:

- **IEC 60947-5-1:** Low-voltage switchgear and controlgear, Part 5-1: Control circuit devices and switching elements - Electromechanical control circuit devices
- **IEC 60947-5-1, Annex K:** Special requirements for control switches with direct opening action
- **UL508:** Industrial control equipment
- **IEC 60529:** Degrees of protection provided by enclosures (IP Code)
- **UL 94V-0:** Flammability Standard
- **DIN 41636-6:** Dimensions correspond to type F as defined by the standard
- **DIN 40050-9:** Road vehicles; degrees of protection (IP code); protection against foreign objects; water and contact; electrical equipment
- **DIN 46244:** Tabs for receptacles

# Schaltbau GmbH

For detailed information on our products and services visit our website – or give us a call!

Phone +49 89 9 30 05-0  
Internet [www.schaltbau.de](http://www.schaltbau.de)  
e-mail [contact@schaltbau.de](mailto:contact@schaltbau.de)

Find your worldwide contact person. We are here for you, personally!



with compliments:



The production facilities of Schaltbau GmbH have been IRIS certified since 2008.



Certified to DIN EN ISO 14001 since 2002. For the most recent certificate visit our website.



Certified to DIN EN ISO 9001 since 1994. For the most recent certificate visit our website.

## Electrical Components and Systems for Railway Engineering and Industrial Applications

### Connectors

- Connectors manufactured to industry standards
- Connectors to suit the special requirements of communications engineering (MIL connectors)
- Charging connectors for battery-powered machines and systems
- Connectors for railway engineering, including UIC connectors
- Special connectors to suit customer requirements

### Snap-action switches

- Snap-action switches with positive opening operation
- Snap-action switches with self-cleaning contacts
- Snap-action switch made of robust polyetherimide (PEI)
- Snap-action switch with two galvanically isolated contact bridges
- Special switches to suit customer requirements

### Contactors Emergency disconnect switches

- Single and multi-pole DC contactors
- High-voltage AC/DC contactors
- Contactors for battery powered vehicles and power supplies
- Contactors for railway applications
- Terminal bolts and fuse holders
- DC emergency disconnect switches
- Special contactors to suit customer requirements

### Electrics for rolling stock

- Equipment for driver's cab
- Equipment for passenger use
- High-voltage switchgear
- High-voltage heaters
- High-voltage roof equipment
- Equipment for electric brakes
- Design and engineering of train electrics to customer requirements