

# Female cordset

## V31-WM-10M-PUR

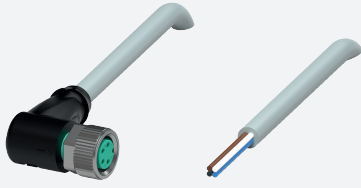

- Degree of protection IP68
- Resistant to microbes and hydrolysis
- Halogen-free
- Specific design protects against loosening and inaccurate installation

Female cordset single-ended M8 angled A-coded, 4-pin, PUR cable grey



### Dimensions

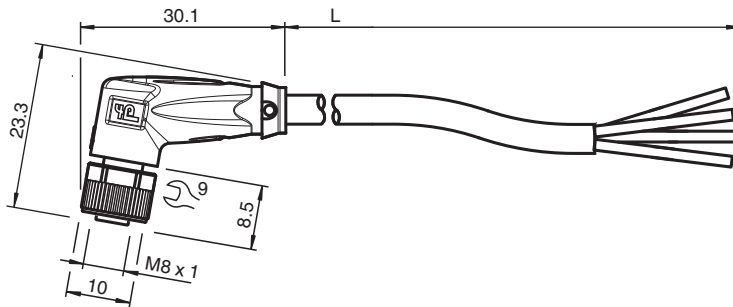

### Technical Data

General specifications			
Connector 1			
Connection			socket
Construction type			M8
Style			angled
Locking			screw connection
Number of pins			4
Coding			A-coded
Connector 2			
Connection			cable end
Electrical specifications			
Operating voltage	$U_B$		max. 30 V AC/DC
Operating current	$I_B$		max. 3 A
Conformity			
Degree of protection			EN 60529
Plug connection			connector M8 x 1 : IEC 61076-2-104
Halogen-free			IEC 60754-1

Release date: 2022-11-28 Date of issue: 2022-11-29 Filename: 116468\_eng.pdf

Refer to "General Notes Relating to Pepperl+Fuchs Product Information".

## Technical Data

<b>Ambient conditions</b>		
Ambient temperature		
Plug connector		-40 ... 90 °C (-40 ... 194 °F)
Cable, fixed		-40 ... 80 °C (-40 ... 176 °F)
Cable, flexing		-20 ... 80 °C (-4 ... 176 °F)
Pollution degree		3
<b>Mechanical specifications</b>		
Plug connector		
Tightening torque		0.4 Nm
Loosening protection		available
Tool installation		straight knurling and hexagon nut SW = 9 mm
Mating cycles		min. 100
Degree of protection		IP68
Cable		according to IEC/EN 60228 (DIN VDE 0295) class 5
Sheath diameter		4.3 mm
Bending radius		> 15 x cable diameter, moving > 8 x cable diameter, fixed
Sheath stripping force		max. 60 N / 500 mm
Sheath color		grey (similar to RAL 7001)
Number of cores		4
Core cross section		0.25 mm <sup>2</sup>
Cores color		Core 1: brown Core 2: white Core 3: blue Core 4: black
Core construction		14 x 0.15 mm Ø
Length	L	10 m
Cable code		Li 9Y 11Y 4 x 0,25
Drag chain suitability		
Drag chain cycles		max. 50 / day
Motion velocity		max. 0.3 m/s
<b>Material</b>		
Halogen-free		yes
Plug connector		
Screw connection		Zinc diecast, nickel-plated
Body		TPU, black
Seal		FKM
Contact surface		gold plated (Au)
Flammability		V-2
Cable		
Sheathing		PUR based on polyether
Core insulation		PP
Chemical resistance		good
Microbial resistance		yes
Hydrolysis resistance		yes





Release date: 2022-11-28 Date of issue: 2022-11-29 Filename: 116468\_eng.pdf

## Connection Assignment



- 1 ) \_\_\_\_\_ BN
- 2 ) \_\_\_\_\_ WH
- 3 ) \_\_\_\_\_ BU
- 4 ) \_\_\_\_\_ BK

## Accessories

	<b>MH V3-SCREWDRIVER</b>	Torque screwdriver (0.4 Nm)
	<b>MH V3-BIT M8</b>	plug-in cap for M8
	<b>V1/V3-LABELHOLDER</b>	Label holder
	<b>V1/V3-LABEL</b>	Label plate
	<b>MH V3-Holder</b>	Modular universal holder for M8 connectors

Release date: 2022-11-28 Date of issue: 2022-11-29 Filename: 116468\_eng.pdf