

Female connector, field-attachable

V15-W-PG9



- Field-attachable
- Metal locking
- Knurled nut suitable for tool assembly
- cURus approval

Female connector M12 angled A-coded 5-pin, for cable diameter 6 - 8 mm, field-attachable



Dimensions

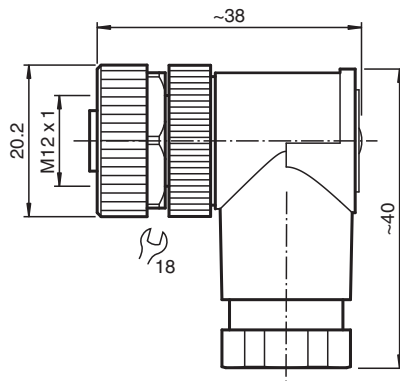

Technical Data

General specifications

Connector 1		
Connection		socket
Construction type		M12
Style		angled
Locking		screw connection
Number of pins		5
Coding		A-coded
Customization		Coding rotateable in steps of 90°
UL File Number		E363587

Electrical specifications

Operating voltage	U _B	max. 48 V AC / 60 V DC
Operating current	I _B	max. 4 A
Insulation resistance		min. 100 MΩ

Conformity

Degree of protection		EN 60529
Plug connection		connector M12 x 1 : IEC 61076-2-101

Release date: 2021-12-08 Date of issue: 2021-12-08 Filename: 117133_eng.pdf

Refer to "General Notes Relating to Pepperl+Fuchs Product Information".

Pepperl+Fuchs Group
www.pepperl-fuchs.com

USA: +1 330 486 0001
fa-info@us.pepperl-fuchs.com

Germany: +49 621 776 1111
fa-info@de.pepperl-fuchs.com

Singapore: +65 6779 9091
fa-info@sg.pepperl-fuchs.com

PEPPERL+FUCHS

Technical Data

Ambient conditions		
Ambient temperature		-40 ... 85 °C (-40 ... 185 °F)
Pollution degree		3
Mechanical specifications		
Plug connector		
Tightening torque		0.6 Nm
Tool installation		straight knurling , hexagon nut SW = 18 mm
Mating cycles		min. 50
Degree of protection		IP67
Connection		screw terminals for max. 0.75 mm ² / AWG 18
Cable		
Sheath diameter		6 ... 8 mm
Mass		26.92 g
Material		
Plug connector		
Screw connection		Zinc diecast, nickel-plated
Body		PA, black
Contact surface		CuSnZn

Connection Assignment

