

EMS MV5/AV5

Energy management system



Description

EMS is an all-in-one smart meter, gateway, web-server and controller. It is an energy analyser that can monitor one three phase load (or 3 single-phase loads), expandable to 10 three-phase loads via ESY bus add-ons.

EMS is a gateway that supports several communication protocols including Modbus (TCP/IP and RTU), BACnet IP, FTP, FTPS, SFTP, Rest-API and MQTT which allow for rapid integration with third-party software and any other device connected to the network (e.g., building energy management systems and inverters or charging stations).

EMS is a stand-alone controller: with two Ethernet ports, RS485 ports and Wi-Fi communication for a easy and simple programming via smart-phone; energy data readings can be pushed to external servers/Cloud and can be stored in the internal memory of the device.

EMS is a web server: for data analytics presented via dashboards, charts and reports.

By combining accurate metering, a powerful Linux powered CPU in a small case, EMS is really a complete Energy Management System in a box.

Compatible with any 333 mV current transformer and with any current transformer with 5 A secondary current. It can be installed in systems with rated current up to 10 kA, even in retrofit applications if used with openable transformers like CTA or CTD S.

Benefits

- **All-in-one Energy Management System:** fully integrated smart meter, data logger, gateway, web server and controller.
- **High measurement accuracy.**
- **User-friendly installation and set up:** the start-up and each function can be managed and configured by a unique web app (compatible with PC and smart-phones).
- **Real-time data acquisition.**
- **Accurate and reliable 3-phase energy measurement for consumption and feed-in.**
- **Scalability:** it is easy to scale up the system thanks to additional ESY accessories.
- **Interoperability.** By leveraging its automation-server functions, it is easy to exchange data with other systems via FTP, SFTP, FTPS, SMTP, Rest-API, MQTT, Modbus and BACnet.
- **Generic MQTT compatibility:** EMS can send real-time data and data can be stored in the EMS database to a generic MQTT broker. Moreover, EMS has been validated for working with Azure IoT and is compatible with Amazon AWS IoT.
- **Powered by MAIA Cloud:** secure and reliable system for remotely managing, setting and operating EMS units Worldwide.
- **Optimised user interface and data management.** Improved user experience for fast commissioning and easy daily operation thanks to a multi-user system.
- **Over-the-Air (OTA) Updates.** Seamlessly update the firmware of multiple deployed devices remotely via the MAIA Cloud portal, ensuring continuous improvement and maintenance without on-site intervention.
- **Quick configuration.** The configuration wizard that runs when the system is started for the first time allows you to put the unit into operation without errors and in few seconds.
- **Cybersecurity (IoT Security Rating):** Security Capabilities Verified by UL to Level SILVER for EMS (Security Enhancement).
- **Optional Open-EM system:** for allowing third party software modules to be embedded into EMS so to build custom solutions for specific applications.

References

How to order

 **EMS10**

Enter the code option instead of

Code	Options	Description
EMS10	-	-
<input type="checkbox"/>	AV5	5 A CT connection
	MV5	333 mV CT connection
<input type="checkbox"/>	O1	Digital output
	S1	RS485 Modbus RTU
<input type="checkbox"/>	X	-

MAIA Cloud licences

Information	Description	Document
UWP-LICENCE-M01B	MAIA PLUS LICENCE-12 MONTHS VPN	Licence Code EIM pdf
UWP-LICENCE-M02B	MAIA PLUS LICENCE-24 MONTHS VPN	
UWP-LICENCE-M04B	MAIA PLUS LICENCE-48 MONTHS VPN	
UWP-LICENCE-M05B	MAIA PLUS LICENCE-60 MONTHS VPN	
UWP-LICENCE-M25B	MAIA PLUS LICENCE-300 MONTHS VPN	
UWP-LICENCE-300C	MAIA PLUS LICENCE 300 CREDITS	

Accessory modules

Module code	Connectable CT	Size
ESY3XMV	3 x 333 mV	1 DIN
ESY3XAV5	3 x 5 A	

 **Compatible devices**

Device	Instruction manual
UWP-MODEM-KIT-4G-E02	www.gavazziautomation.com/UWP-Modem-Kit-4G-E02.pdf
UWP-ROUT-KIT-E01	www.gavazziautomation.com/UWP-ROUT-KIT-E01_A3.pdf
UWP-ROUT-KIT-US	www.gavazziautomation.com/UWP-ROUT-KIT-US_A3.pdf



Main metering functions

- Measure active, reactive and apparent energy
- Measure the main electrical variables
- Measure the load/analyser run hours
- Measure the total harmonic distortion (THD) of current and voltages
- Multi Load monitoring via plug'n play ESY BUS add-on modules



Main IoT features

- Self power supply via voltage inputs
- Data transmission via Modbus BACnet, MQTT, FTP, SFTP, FTPS, Rest-API
- Embedded Wi-Fi for easy programming/data analysis
- Reliable data storage within the embedded database
- Data analytics organized in dashboards and widgets
- Display analytics based on the stored data via the embedded web server
- Embedded reporting system (scheduled or on-demand reports)
- Secure multi-user access either local (embedded web app) or remote (MAIA Cloud)
- Remote access and firmware update via MAIA Cloud (commissioning and troubleshooting)
- Two Ethernet ports (switch mode for easy cascading of connected devices)
- BTL certified
- IoT certification for Amazon AWS and Microsoft Azure
- Embedded display for diagnostics and variables

Architecture

Electrical connection

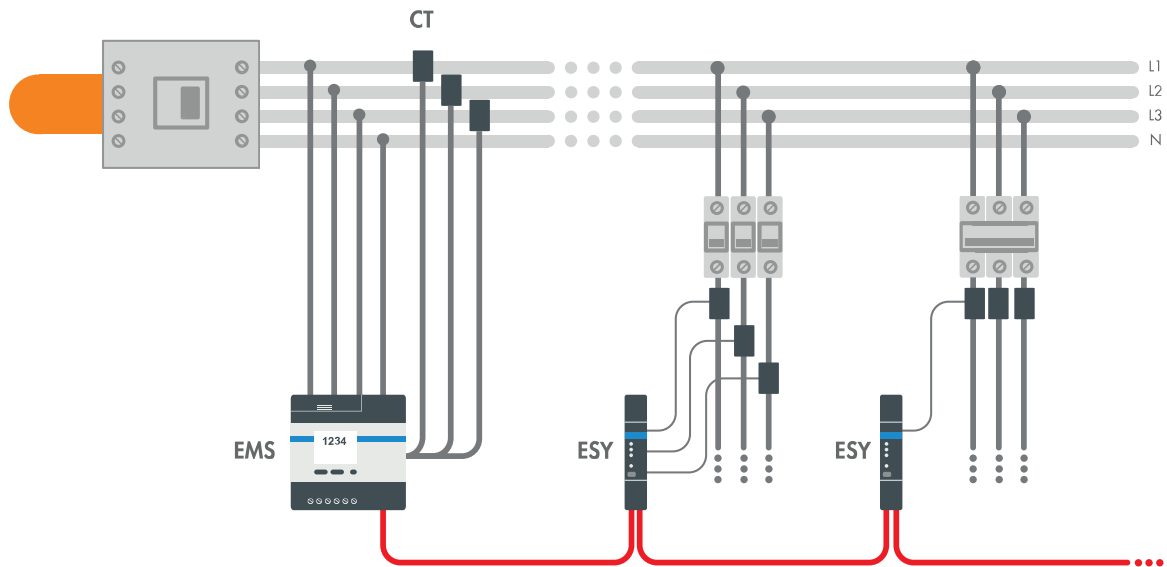



Connectivity

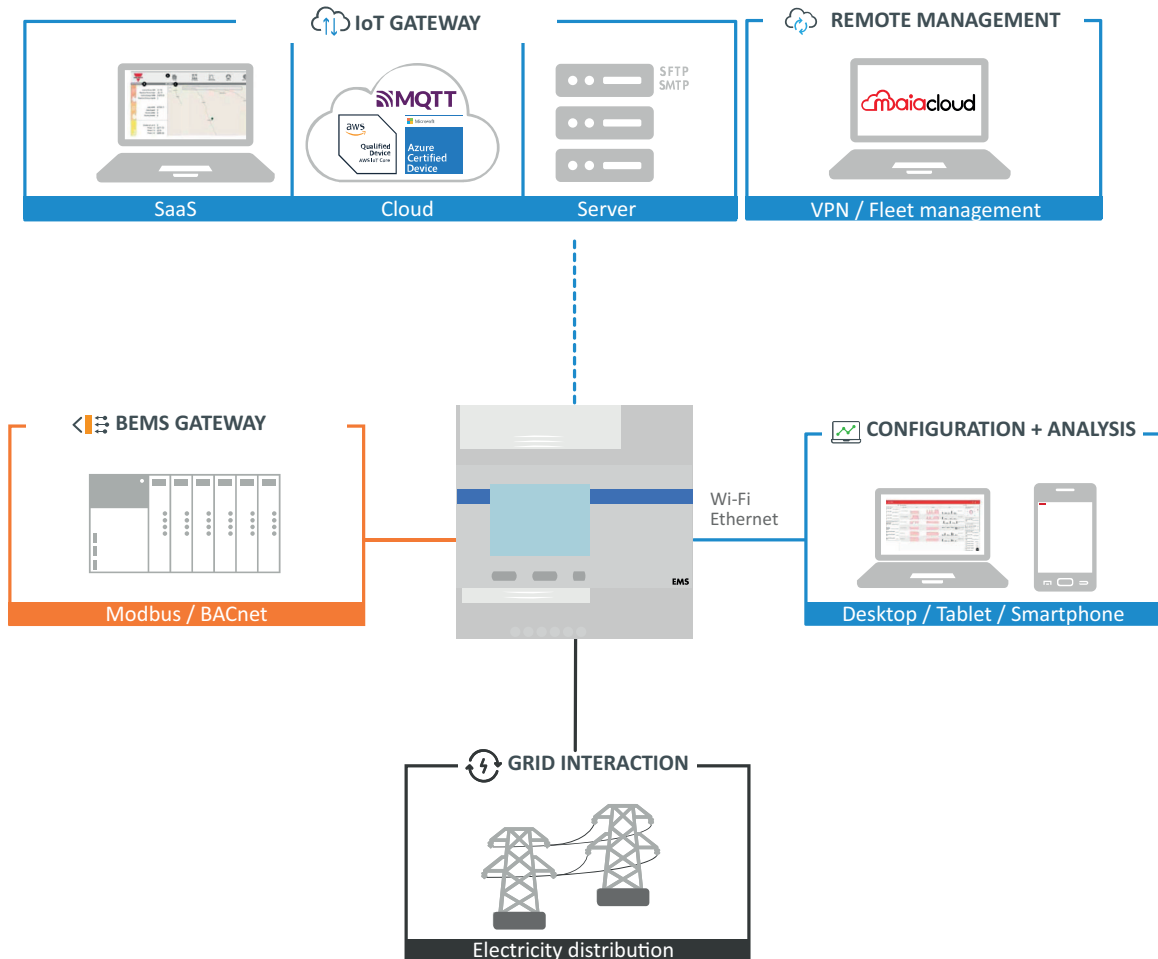

Structure

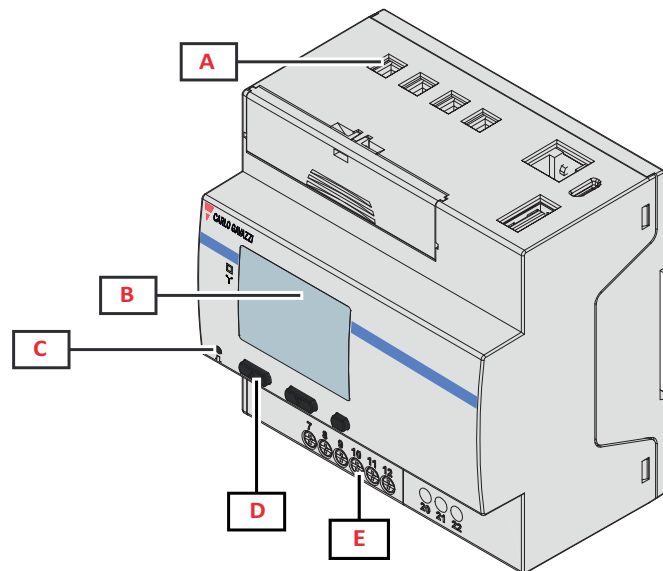

Area	Description
A	Voltage inputs
B	Display
C	LED
D	Browsing and configuration buttons
E	Digital input, digital output and communication connections

Features

General

Material	Housing: PBT Transparent cover: polycarbonate Compliant with UL and CE marks
Dimensions	5-DIN module
Weight	Approx. 500 g
Protection degree	Front: IP40 Screw terminals: IP20
Terminals	<p>AV5/MV5 voltage input (four terminals): Screw type: Combo head Wire size: min. 0.2 mm², max. 2.5 mm² (stranded or solid) Torque: 0.45 Nm max. Sealable, pitch 10 mm</p> <p>AV5/MV5 current input (six terminals): Screw type: Combo head Wire size: min. 0.2 mm², max. 2.5 mm² (stranded or solid) Torque: 0.45 Nm max. Sealable, pitch 5 mm</p> <p>RS485 Modbus Master port: Screw type: Combo head Wire size: min. 0.2 mm², max. 2.5 mm² (stranded or solid) Torque: 0.45 Nm max. Sealable, pitch 5 mm</p> <p>Auxiliary Input/Output (six or four terminals): Screw type: Combo head Wire size: min. 0.2 mm², max. 1.5 mm² (stranded or solid) Torque: 0.4 Nm max. Sealable, pitch 4.6 mm</p>
Mounting	DIN rail
Overvoltage category	III
Pollution degree	2
Protective class	Class II
Rated impulse voltage	4kV

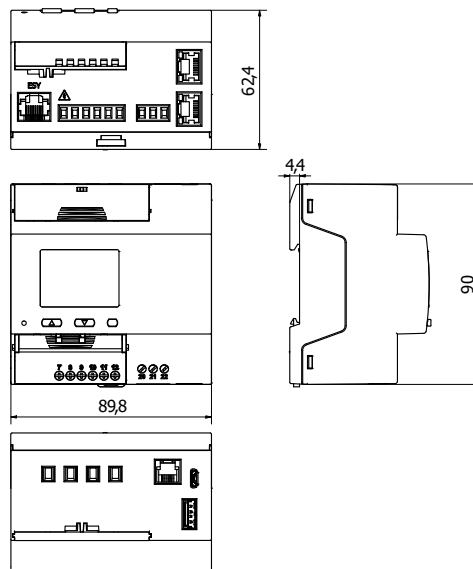

Environmental





Operating temperature	From -25 to +70 °C / from -13 to +158 °F
Storage temperature	From -30 to +70 °C / from -22 to 158 °F
Altitude	Max 3000 m / 9842.52 ft

Note: R.H. < 90 % non-condensing @ 40 °C / 104 °F.

Power Supply

Type	Self power supply
Frequency	50/60 Hz
Consumption	10 W / 15 VA

Compatibility and conformity

<p>Directives</p>	<p>RED 2014/53/EU RoHS 2011/65/EU</p>
<p>Standards</p>	<p>Radio: EN 300 328 V2.2.2 EMC (Electro Magnetic Compatibility): EN 301 489-1 V2.2.3, EN 301 489-17 V3.2.4, EN 62052-11.2021 Safety: EN IEC 61010-1 Health: EN 62311:2020 Metrology: EN IEC 62053-22, EN IEC 62053-23 FCC (USA) Radio Emission: FCC CFR title 47 Part 15C, FCC CFR title 47 Part 2.1091 IC (canadian) radio emission: ISED RSS-247 Issue 3; ISED RSS-102 Issue 5</p>
<p>Approvals</p>	    

Electrical specifications

Electrical system	
Managed electrical system	Single-phase (2-wire) Two-phase (3-wire) Three-phase with neutral (4-wire) Three-phase without neutral (3-wire) Wild-leg system (three-phase, four-wire Delta)

Voltage inputs	
Voltage connection	Direct
Rated voltage L-N (from U_n min. to U_n max.)	120 to 277 V
Rated voltage L-L (from U_n min. to U_n max.)	208 to 480 V
Voltage tolerance	From 0.8 to 1.15 U_n
Overload	Continuous: 1.15 U_n max.
Input impedance	Refer to "Power supply"
Frequency	From 45 to 65 Hz

Note: EMS can be also installed in a wild-leg system (three phases, four-Delta wires), where one of the phase-neutral voltages is higher than the other two.

Current inputs	AV5	MV5
Current connection	Via CT	Via 333 mV current sensor
CT transformation ratio	2000 max.	-
Primary current	10 kA max.	10 kA max.
Rated current (I_n) input	5 A	333 mV
Minimum current (I_{min})	0.05 A	0.01 I_n (0.03 V)
Maximum current (I_{max})	6 A	1.2 I_n (0.4 V)
Start-up current (I_{st})	5 mA	0.001 I_n (0.003 V)
Overload	For 500 ms: 20 I_{max} (120 A)	For 500 ms: 8 V
Input impedance	< 0.3 VA	100 k Ω
Crest factor	3	1.414 @ I_{max}
Measurement type	by means of internal shunts	with external current sensors

Available measurements

Active energy	Unit	System	Phase
Imported (+) Total	kWh+	●	●
Imported (+) partial	kWh+	●	-
Exported (-) Total	kWh-	●	●
Exported (-) partial	kWh-	●	-
Imported (+) Total by tariff (t1, t2)	kWh+	●	-
Quadrant I, II, III, IV	kWh	●	-

Reactive energy	Unit	System	Phase
Imported (+) Total	kvarh+	●	●
Imported (+) partial	kvarh+	●	-
Exported (-) Total	kvarh-	●	●
Exported (-) partial	kvarh-	●	-
Quadrant I, II, III, IV	kvarh	●	-

Apparent energy	Unit	System	Phase
Total	kVAh	●	-
Partial	kVAh	●	-
Quadrant I, II, III, IV	kVAh	●	-

Run hour meter	Unit	System	Phase
Total (kWh+)	hh:mm	●	-
Partial (kWh+)	hh:mm	●	-
Total (kWh-)	hh:mm -	●	-
Partial (kWh-)	hh:mm -	●	-
Total ON time	hh:mm	●	-

Electrical variable	Unit	System	Phase
Voltage L-N	V	●	●
Voltage L-L	V	●	●
Current	A	●	●
Neutral current	A	●	-

Electrical variable	Unit	System	Phase
Active power	W	•	•
Apparent power	VA	•	•
Reactive power	Var	•	•
Power factor	PF	•	•
Frequency	Hz	•	-
THD current*	THD A %	-	•
THD voltage L-N*	THD L-N %	-	•
THD voltage L-L*	THD L-L %	-	•

*Up to 31th harmonic

Measurements

Method	TRMS measurements of distorted waveforms
--------	--

Measurement accuracy

Current AV5	
From 0.05 I_n to I_{max}	± 0.3% rdg
From 0.01 I_n to 0.05 I_n	± 0.6% rdg

Current MV5	
From I_{min} to 0.05 I_n (PF=1)	± 1% rdg
From 0.05 I_n to I_{max} (PF=1)	± 0.5% rdg
From 0.02 I_n to 0.1 I_n (PF=0.5L - 0.8C)	± 1% rdg
From 0.1 I_n to I_{max} (PF=0.5L - 0.8C)	± 0.6% rdg

Phase-phase voltage	
From U_n min. -20% to U_n max. +15%	$\pm 0.2\%$ rdg

Phase-neutral voltage	
From U_n min. -20% to U_n max. +15%	$\pm 0.2\%$ rdg

Active and appar- ent power	AV5	MV5
From I_{min} to $0.05 I_n$ (PF=1)		
From $0.05 I_n$ to I_{max} (PF=1)	$\pm 0.5\%$ rdg	
From $0.01 I_n$ to $0.05 I_n$ (PF=1)	$\pm 1\%$ rdg	
From $0.1 I_n$ to I_{max} (PF=0.5 L - 0.8 C)	$\pm 0.6\%$ rdg	
From $0.02 I_n$ to $0.1 I_n$ (PF=0.5 L - 0.8 C)	$\pm 1\%$ rdg	
Active energy	Class 0.5S EN IEC 62053-22	Equivalent to class 0.5S EN IEC 62053-22

Reactive power	AV5	MV5
From $0.1 I_n$ to I_{max} ($\sin\phi=0.5$ L - 0.5 C)	$\pm 2\%$ rdg	
From $0.05 I_n$ to I_{max} ($\sin\phi=1$)		
From $0.05 I_n$ to $0.1 I_n$ ($\sin\phi=0.5$ L - 0.5 C)	$\pm 2.5\%$ rdg	
From $0.02 I_n$ to $0.05 I_n$ (PF=1)		
Active energy	Class 2 (EN IEC 62053-23)	Equivalent to class 2 (EN IEC 62053-23)

Frequency	
From 45 to 65 Hz	$\pm 0.1\%$ rdg

Measurement resolution

Variable	Display resolution	Resolution by serial communication
Energy	0.001 kWh/kvarh/kVAh	
Single phase energy	N.A.	0.001 kWh
Power	0.001 kW/kvar/kVA	0.1 W/var/VA
Current*	0.001 A	0.001 A
Voltage	0.1 V	
Frequency	N.A.	0.001 Hz
Power factor	0.01	0.001

(*)Note: value referred to CT ratio =1.

Digital outputs/inputs

Digital inputs

Connection type	Screw terminals
Number of inputs	1
Type	Free contact
Function	Remote status Tariff management Partial meter start/pause Partial meter reset
Features	Open contact voltage: 5 V DC +/- 5% Closed contact voltage: 5 mA max Input impedance: 11.6 k Ω Open contact resistance: \geq 25 k Ω Closed contact resistance: \leq 840 Ω Maximum voltage applicable with no damages: 30 V AC
Configuration parameters	Input function
Configuration mode	Via web app

Digital output

Connection type	Screw terminals
Maximum number of outputs	1
Type	Opto-mosfet
Function	Remote output, alarm
Features	V_{ON} 2.5 V AC/DC, max 100 mA V_{OFF} 42 V AC/DC
Configuration parameters	Output function (remote/alarm) Output normal status (NO or NC)
Configuration mode	Via web app



Input and output insulation

Type	ESY port	Measurement inputs	Digital input	Digital out-puts	RS485 serial port
ESY port	-	Basic	-	-	-
Measurement inputs	Basic	-	Double/ Reinforced	Double/ Reinforced	Double/ Reinforced
Digital input	-	Double/ Reinforced	-	none	none
Digital outputs	-	Double/ Reinforced	none	-	-
RS485 serial port	-	Double/ Reinforced	none	-	-

According to EN IEC 61010-1. Overvoltage category III. Pollution degree 2.



Display

Type	Graphical matrix display
Refresh time	500 ms
Description	128 x 96 backlit LCD
Variable readout	Instantaneous: 5+1 dgt or 5+3 dgt Energy: 8+3 dgt

LED

AV5

The LED is Red coloured. Pulse weight: proportional to energy consumption and depending on the CT ratio, 16 Hz maximum frequency.

Weight (kWh per pulse)	CT ratio
0.001	≤ 7
0.01	$7 < CT \leq 70$
0.1	$70 < CT \leq 700$
1	$700 < CT \leq 2000$

MV5

The LED is Red coloured. Pulse weight: proportional to energy consumption and depending on Primary current (I_n), 16Hz maximum frequency.

Weight (kWh per pulse)	Primary current (I_n)
0.001	≤ 35
0.01	$35 < I_n \leq 350$
0.1	$350 < I_n \leq 3500$
1	> 3500

Ports

Ethernet

Number of ports	2
Standard	ISO9847
LAN configuration	Static or DHCP IP Address; Net Mask; Default Gateway, DNS (primary, secondary)
Protocols	HTTP, HTTPS, FTP, FTPS, SFTP, Modbus TCP/IP, SMTP, NTP, Azure IoT Hub, AWS IoT, BACnet IP, Rest-API, Multicast DNS (mDNS)
Connection type	2 x RJ45 connector (10 Base-T, 100 Base-TX) Maximum distance: 100 m Integrated switch function to connect another Ethernet device

RS485

Number of ports	2
Function	1 Modbus slave port (for S1 versions) and 1 Modbus master port
Number of slaves (for the master port)	Up to 12
Connections	2-wire. Max. distance: 600 m
Protocol	Modbus RTU
Data format	Selectable: 1 start bit, 7/8 data bit, no/odd/even/ parity, 1/2 stop bit
Baud rate	Selectable: from 2400 to 115200

HAN port

Number of ports	1
Function	Access real time energy consumption from the smart meter
Connection	RJ12, 6P6C
Protocol	DSMR 5
Baud rate	Fixed: 115200
Data format	Fixed: data bit 8, no parity , 1 stop bit

ESY bus

Number of ports	1
Function	Connection with ESY bus accessories
Cable type	Min. Cat. 5E, not crossed
Cable length	Max. 100 m
Bus type	Daisy chain (refer to standard Modbus RTU requirements)
Number of ESY extension modules	Max. 10 units

USB micro bus

Type	High-speed USB 2.0 micro-B
Mode	Device
Speed	60 MB/s
Function	RNDIS (virtual Ethernet) Network access via IP: 192.168.254.254

USB type A port

Type	High-speed 2.0 Type-A
Mode	Host
Communication speed	60 MB/s
Function	Modem communications
Supported devices	USB modem/router can be directly connected
Supported file system	USB mass storage not supported

 Wi-Fi

Technology	Wi-Fi IEEE 802.11 b/g/n 20/40 MHz
Centre frequency range of operating channel	2412 - 2472 MHz
Maximum EIRP output power	18.34 dBm
Number of channels	13
Channel bandwidth	20MHz, 40MHz
Modulations	DSSS, OFDM
Number of Tx antennas	1
Installation category	Mobile
Connectivity	2.4 GHz Spectrum Capabilities Wi-Fi CERTIFIED™ b Wi-Fi CERTIFIED™ g Wi-Fi CERTIFIED™ n
Optimization	WMM®
Security	Protected Management frames for SoftAP mode: WPA2™-Personal 2021-01 Protected Management frames Station mode: WPA2™-Enterprise 2018-04 WPA2™-Personal 2021-01 WPA3™-Enterprise 2020-02 WPA3™-Personal 2020-02 WPA™-Enterprise WPA™-Personal
Modes	SoftAP Station



Connection Diagrams

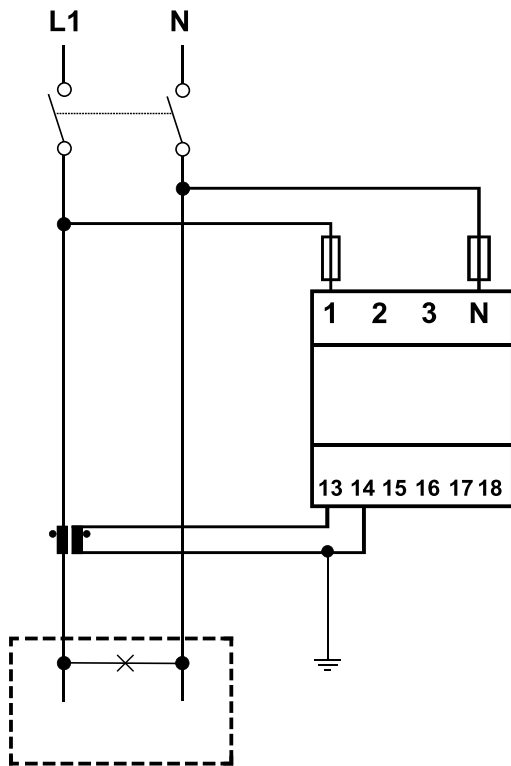

Single-phase system

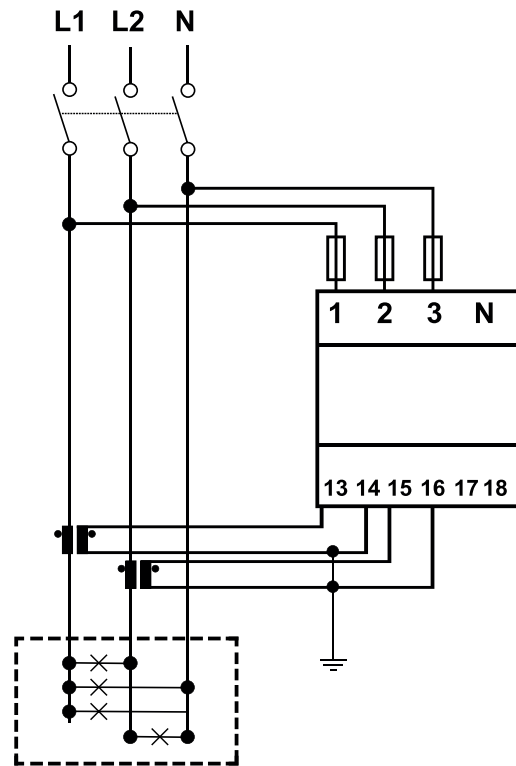

Bi-phase system

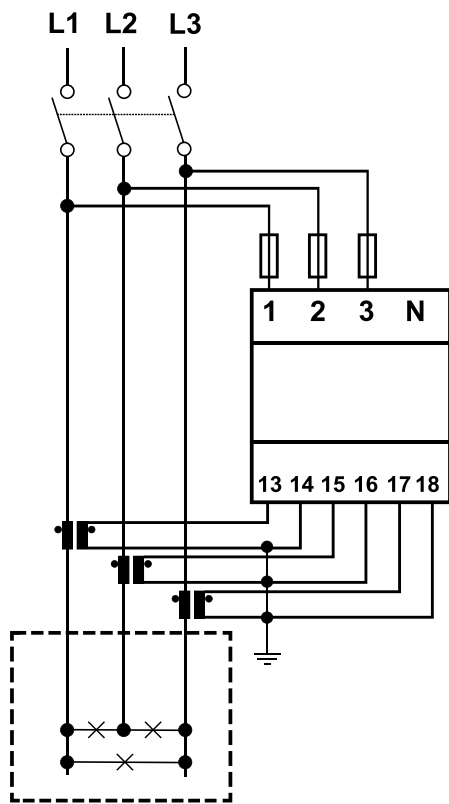

Three-phase without neutral (3-wire)

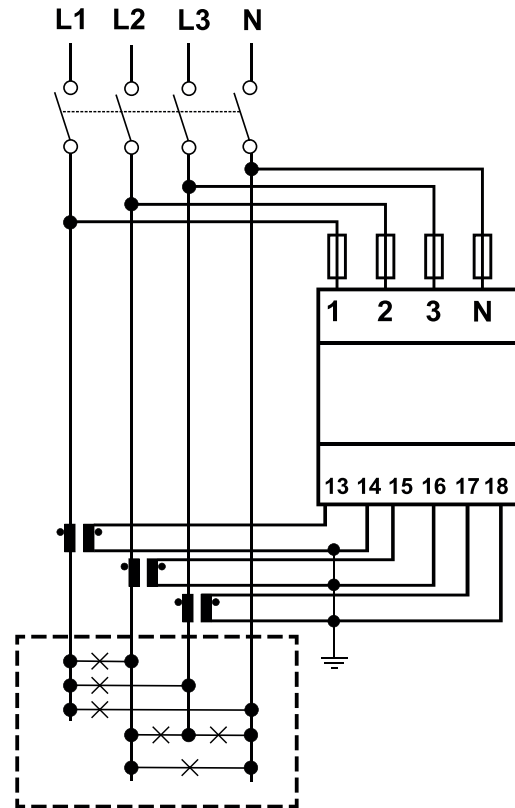

Three-phase with neutral (4-wire).

Communication

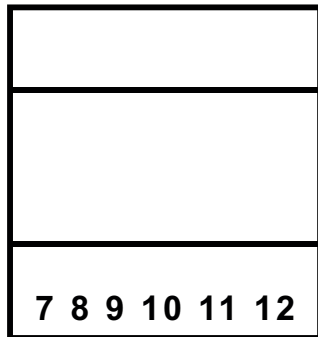

Digital_Input

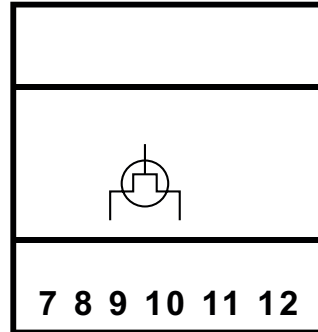

Digital_Output

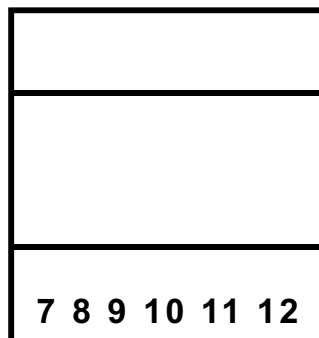

B+ A- GND

Last device on Modbus RS485

Cybersecurity

Introduction

Cybersecurity is the practice of protecting systems, networks, and programs from digital attacks. These cyberattacks are usually aimed at:

- accessing, changing, or destroying sensitive information;
- extorting money from users;
- interrupting normal business processes.

Implementing effective cybersecurity measures is particularly challenging today because there are more devices than people, and attackers are becoming more innovative.

For EMS MV5/AV5, the security capabilities have been verified by UL to Level SILVER.

The SILVER rating certifies the enhanced security capabilities of EMS MV5/AV5 regarding:

- Access Control
- Industry Privacy Best Practices
- Product Security Maintenance.



Fig. 1 UL Verified Level



Fig. 2 IoT Security Rating Levels Guide

Pillars

- Secure boot.
- Easy upgrade function. Web app notifies users about the availability of a new software and firmware version; the whole upgrade process is managed by the EMS MV5/AV5.
- Fleet management: One-click over-the-air (OTA) update of multiple devices simultaneously.
- Secure access: thanks to MAIA Cloud, you can access a EMS MV5/AV5 system through a secure VPN (virtual private network).
- Minimalist approach: EMS MV5/AV5 has been designed to include only the necessary sub-systems into a highly optimized linux core, so to avoid unnecessary risks due to attacks to unmonitored services.

Network service ports

Inbound communication

Port	Protocol	Service	Configurable	Default service
*80	TCP	HTTP	NO	Enable
443	TCP	HTTPS	NO	Enable
52325	TCP	SSH	NO	Enable
5353	UDP	mDNS	NO	Enable
67	UDP	DHCP server	NO	Enable
47808	UDP	BACnet gateway	YES	Disable
502	TCP	Modbus gateway	YES	Disable

*Note: this port is redirected to 443

Outbound communication

Port	Protocol	Service	Configurable	Default service
443	TCP	MAIA Cloud	NO	Enable
1194	UDP	MAIA Cloud (VPN)	NO	Enable
21	TCP	FTP	YES	Disable
22	TCP	SFTP	YES	Disable
990	TCP	FTPS	YES	Disable
53	UDP	DNS	NO	Enable
123	UDP	NTP	NO	Disable
25	TCP	SMTP	YES	Disable
587	TCP	SMTPS	YES	Disable
8883	TCP	MQTT	YES	Disable
8883	TCP	MQTTS	YES	Disable



COPYRIGHT ©2025

Content subject to change. Download the updated version:

www.gavazziautomation.com