

Wallcab 270

E-no: 2700944

Assembly instructions

All electrical installation work must be carried out by an authorized installer and meet the installation requirements in the country of use.

Wallcab Consists of:

Hood	1 pcs
Roof	1 pcs
Wallplate	1 pcs
Terminal block	1 pcs
Service hatch	1 pcs

Fasteners Included:

M6x16 A2-70	4 pcs
M6x16 Torx Pin	4 pcs
Joint Washer A2	4 pcs
Flat Washer A2 big	4 pcs
Flat Washer A2 small	4 pcs
M6 Hexagon Nut A2	4 pcs



Next Green AB
Brudtallsvägen 14
SE-792 32 MORA
SWEDEN

www.nextgreen.se
info@nextgreen.se

Before installation

We recommend preparing the installation before you are on site.

Recommended materials (not included):

Ground cable, end sleeves, ring cable lugs, straps and flexibel cable.
RCBO/RCCB

1 Mounting

Use the charging box drilling template and / or measure the hole pattern on the mounting surface. Drill holes and mount the charging box on the body. Make sure screws can not damage anything inside the Wallcab.

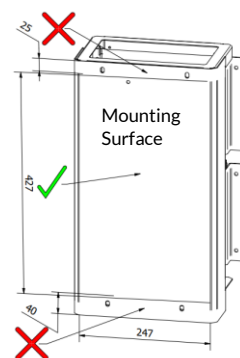

2 Mounting Wallplate

Mount the wallplate at an appropriate height (See charging box instructions) Attach terminal block to DIN rail. Feeder cable may come from above and pass behind the wallplate and enter Wallcab from bottom.

Cable Routing

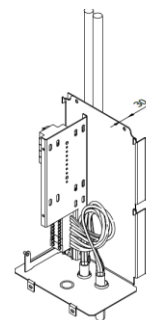

M25 Nockout

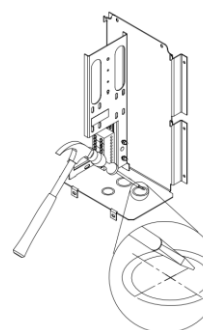

M32 Nockout

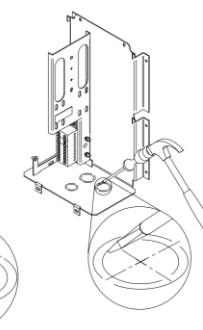

3 Ground Cables

Connect a ground cable between the terminal block and wallplate. Connect other ground points to wallplate. Use a small loop to be able to hang the hood on the upper hooks if necessary.

Ground Cables

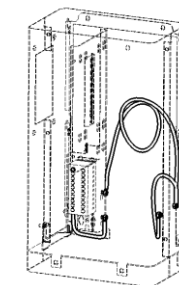

Ground cables are connected with 1pc joint washer and 1pc hexagon nut.

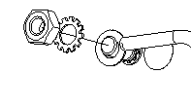

4 Cable Routing

Connect the flexible cable between the RCBO/RCCB and the charger through the bottom hole in the base. Make cables long enough for you to hang the hood onto the hooks during assembly. Excess cable is then pushed back into the Wallcab. If necessary, relieve the cables with cable ties

Cable Routing int.

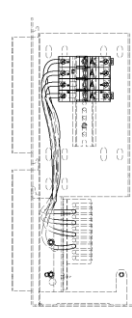

Cable Routing ext.

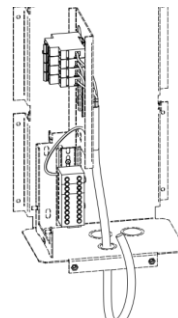

Hooked Body

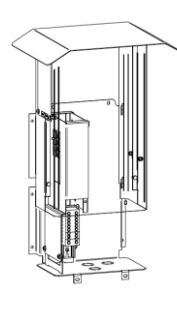

Some chargers can be mounted so that the cable runs through the hood. Make sure that the lead-through is waterproof and that the wires cannot be damaged by sharp edges.

5 Complete installation

Hook the hood to the wallplate. Connect the charging box according to the charging box manual. Mount the roof. Use the big washers on the front side of the hood. Operation of the RCBO/RCCB is done through the service hatch on the side of the unit.

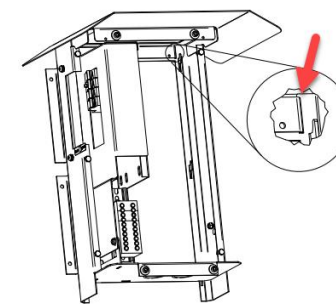

Fasteners

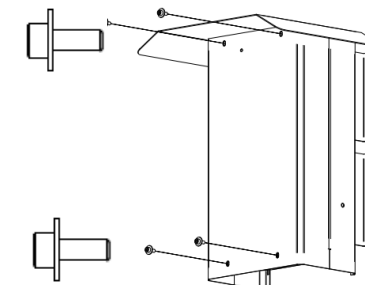

Product specification

Rated Voltage 230/400VAC - 3~, 50-60Hz
Rated Current 130A (Cu), 100A (Al)
Installation Systems TN/TT/IT
Installation Indoor/Outdoor - on wall

Terminal Block: Eldon EKS 525
E-number 2251130

Dimensions without roof 270x490x200 mm

Meets Standard / Directives IEC 61439-7, IP44, IK10

Recycle as: Metal

Wallcab 270

E-nr: 2700944

Monteringsanvisning

Allt elinstallationsarbete måste utföras av en auktoriserad installatör och uppfylla installationskraven i användningslandet.

Innehåller:

Huv	1 st
Tak	1 st
Väggdel	1 st
Plint EKS 525	1 st
Servicelucka	1 st

Medföljande fästelement:

M6x16 A2-70	4 st
M6x16 Torx Pin	4 st
Taggbricka A2	4 st
Planbricka A2 stor	4 st
Planbricka A2 liten	4 st
M6 Sextantsmutter A2	4 st



Next Green AB
Brudtallsvägen 14
SE-792 32 MORA
SWEDEN

www.nextgreen.se
info@nextgreen.se

Inför installation

Rekommenderas att förbereda innan man är på plats.

Material som inte ingår:

Kabel, jordkabel, ändhylsor, ringkabelskor, buntband och flexibel kabel.

Jordfelsbrytare/personskyddsautomat.

1 Montering laddbox

Mätta in laddboxen på huvens monteringsyta mha laddboxens bormmall och montera laddboxen. Försäkra dig om att skruvarna inte tar i något på insidan eller riskerar att skada kablaget.

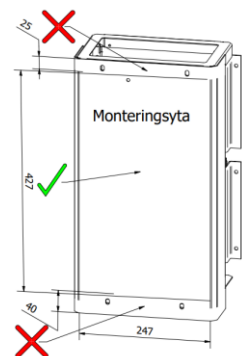

2 Montering väggplatta

Skruva upp väggplattan på lagom höjd. Se laddboxens instruktioner hur högt uttaget ska sitta. Klicka fast plinten på skenan. Matarkabel kan komma från ovasidan och passera bakom för att sedan tas in i Wallcab från undersidan. Nockouts är anpassade för M25 och M32 förskruvning. Se nedan.

Elddragning matarkabel

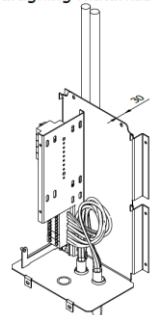

M25 Nockout

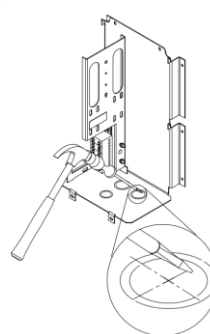

M32 Nockout

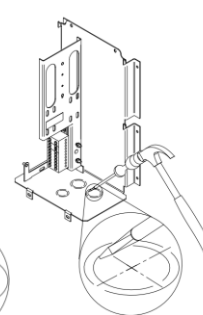

Elddragning GND

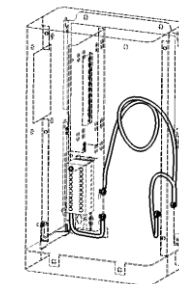

Jordpunkt monteras med taggbricka och mutter.

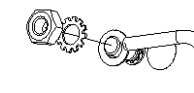

Produktspecifikation

Märkspänning 230/400VAC - 3~, 50-60Hz
Märkström 130A (Cu), 100A (Al)
Elsystem TN/TT/IT
Installationsplats Inomhus/Utomhus - på vägg

Plint: Eldon EKS 525
E-nummer: 2251130

Dimensioner utan tak 270x490x200 mm

Uppfyller:  IEC 61439-7, IP44, IK10

Återvinning Metall

4 Övrig kabeldragning

Dra flexibel kabel från RCBO/RCCB till laddboxen via genomföringen i bottenplattan. Denna bör vara lång nog för att kunna hänga upp huvnen på upphaket vid behov. Överskottet skjuts tillbaka in i Wallcab. Vid behov, dragavlasta kablarna med buntband.

Elddragning plint

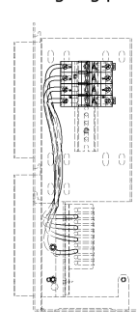

Elddragning laddbox

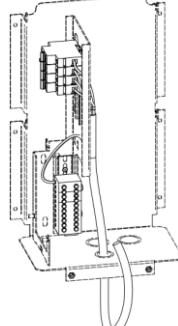

Upphakad

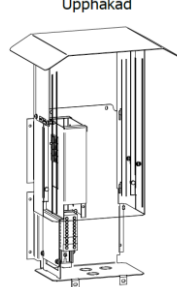

Vissa laddare kan monteras så kabeln går via laddarens kabelintag på baksidan. Viktigt är att genomföringen i huvnen inte skadar kabel och att den blir tillräckligt vattentät.

5 Slutför installationen

Haka på huvnen på väggplattan. Koppla in laddboxen enligt laddboxens instruktioner. Montera taket. Använd stora brickor på framsidan. Testa enheten enligt eget protokoll. Manövrering av RCBO/RCCB sker genom serviceluckan på enhetens sida.

