

KNOCK-OUT
2x $\phi 25/\phi 32+\phi 16$
upptill och nertill
och $\phi 25$ i botten
Förskruvning
2xM32 $\phi(15-21)$
1xM16 $\phi(5-10)$

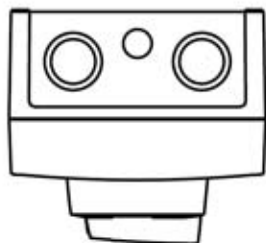
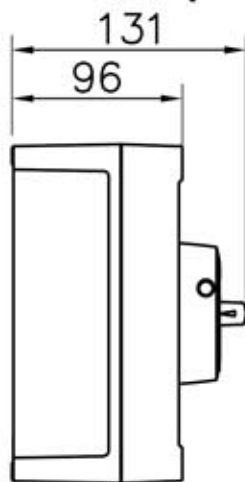
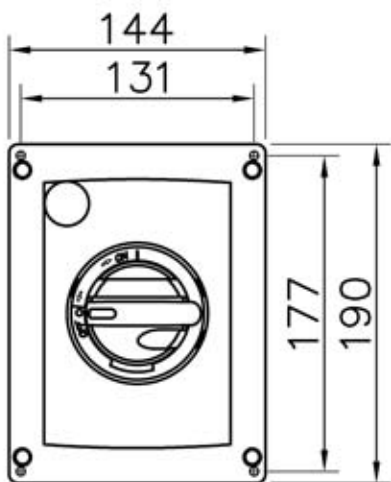

Hjälpkontakt, 1 växlande
Anslutningar, Cu 1.5-16mm²
N, Cu 2.5-35mm²
PE, Cu 2.5-35mm²