

HUAWEI MERC-600W-PA0

User Manual

Issue 07
Date 2026-02-10



Copyright © Huawei Digital Power Technologies Co., Ltd. 2026. All rights reserved.

No part of this document may be reproduced or transmitted in any form or by any means without prior written consent of Huawei Digital Power Technologies Co., Ltd.

Trademarks and Permissions



HUAWEI and other Huawei trademarks are the property of Huawei Technologies Co., Ltd.

All other trademarks and trade names mentioned in this document are the property of their respective holders.

Notice

The purchased products, services and features are stipulated by the contract made between Huawei Digital Power Technologies Co., Ltd. and the customer. All or part of the products, services and features described in this document may not be within the purchase scope or the usage scope. Unless otherwise specified in the contract, all statements, information, and recommendations in this document are provided "AS IS" without warranties, guarantees or representations of any kind, either express or implied. The information in this document is subject to change without notice. Every effort has been made in the preparation of this document to ensure accuracy of the contents, but all statements, information, and recommendations in this document do not constitute a warranty of any kind, express or implied.

Huawei Digital Power Technologies Co., Ltd.

Address: Huawei Digital Power Antuoshan Headquarters
Futian, Shenzhen 518043
People's Republic of China

Website: <https://digitalpower.huawei.com>

More Information

Huawei Digital Power Information Experience Center

<https://info.support.huawei.com/Energy/info>



About This Document

Purpose

This document describes the Smart PV Optimizer in terms of its overview, installation, commissioning, maintenance, and troubleshooting. Before installing and operating the Smart PV Optimizer, read this document carefully to understand the safety precautions and get familiar with the functions and features of the Smart PV Optimizer.

The figures provided in this document are for reference only.

Statement

In this document, MERC only refers to a specific model of Huawei Smart PV Optimizer.



Intended Audience




This document is intended for:

- Technical support engineers
- Hardware installation engineers
- Commissioning engineers
- Maintenance engineers

Symbol Conventions

The symbols that may be found in this document are defined as follows.

Symbol	Description
 DANGER	Indicates a hazard with a high level of risk which, if not avoided, will result in death or serious injury.
 WARNING	Indicates a hazard with a medium level of risk which, if not avoided, could result in death or serious injury.

Symbol	Description
 CAUTION	Indicates a hazard with a low level of risk which, if not avoided, could result in minor or moderate injury.
 NOTICE	Indicates a potentially hazardous situation which, if not avoided, could result in equipment damage, data loss, performance deterioration, or unanticipated results. NOTICE is used to address practices not related to personal injury.
 NOTE	Supplements the important information in the main text. NOTE is used to address information not related to personal injury, equipment damage, and environment deterioration.

Change History

Changes between document issues are cumulative. The latest document issue contains all the changes made in earlier issues.

Issue 07 (2026-02-10)

Updated [2.4 Configuration Principles](#).

Issue 06 (2025-12-30)

- Added functions and the scenario where optimizers are configured for all PV modules connected to an MPPT.
- Added a statement in [About This Document](#).

Issue 05 (2025-04-20)

Updated [2.4 Configuration Principles](#).

Issue 04 (2025-03-17)

Updated [1.2 Electrical Safety](#).

Issue 03 (2025-01-20)

Updated [2.4 Configuration Principles](#).

Updated [3.6 Checking the Optimizer Status](#).

Issue 02 (2024-07-15)

Updated the configuration principles in [2.4 Configuration Principles](#).

Added the description that power grid deployment is not supported in optimizer scenarios in [3.1 Precautions](#).

Updated the checklist for abnormal cable connections in [3.4 Connecting Cables](#).

Added the optimizer operation description in [4 System Maintenance](#).

Updated the conditions for triggering rapid shutdown in [4.2 Rapid Shutdown](#).

Updated the alarm list in [4.4 Alarm List](#).

Added [4.7 PV Module-Level Diagnosis](#).

Issue 01 (2024-03-31)

This issue is the first official release.

Contents

About This Document.....	ii
1 Safety Information.....	1
1.1 Personal Safety.....	2
1.2 Electrical Safety.....	4
1.3 Environment Requirements.....	9
1.4 Mechanical Safety.....	10
2 Product Overview.....	15
2.1 Model Number Description.....	15
2.2 Overview.....	16
2.3 Structure.....	18
2.4 Configuration Principles.....	19
3 Installation and Commissioning.....	23
3.1 Precautions.....	23
3.2 Installation Requirements.....	24
3.3 Installing the Device.....	24
3.4 Connecting Cables.....	27
3.5 Physical Layout.....	31
3.6 Checking the Optimizer Status.....	31
4 System Maintenance.....	33
4.1 Disconnection Detection.....	34
4.2 Rapid Shutdown.....	36
4.3 O&M for PV Modules.....	37
4.4 Alarm List.....	39
4.5 Replacing and Adding an Optimizer.....	40
4.5.1 Scenario 1: Replacing an Optimizer (on the FusionSolar App).....	40
4.5.2 Scenario 2: Replacing an Optimizer (on the Local Device Commissioning Screen).....	42
4.5.3 Scenario 3: Replacing an Optimizer (on the FusionSolar SmartPVMS).....	44
4.6 Troubleshooting Suggestions Against Inefficient PV Modules.....	45
4.7 PV Module-Level Diagnosis.....	47
5 Technical Specifications.....	48
5.1 MERC-600W-PA0 Technical Specifications.....	48

6 FAQ	50
6.1 How Do I Identify a Faulty Optimizer by Measuring the Voltage?.....	50
6.2 How Do I Delete an Optimizer and Update the Physical Layout (on the FusionSolar SmartPVMS)?.....	51
6.3 How Do I Obtain Contact Information?.....	52
A Acronyms and Abbreviations	54

1 Safety Information

Statement

Before transporting, storing, installing, operating, using, and/or maintaining the equipment, read this document, strictly follow the instructions provided herein, and follow all the safety instructions on the equipment and in this document. In this document, "equipment" refers to the products, software, components, spare parts, and/or services related to this document; "the Company" refers to the manufacturer (producer), seller, and/or service provider of the equipment; "you" refers to the entity that transports, stores, installs, operates, uses, and/or maintains the equipment.

The **Danger, Warning, Caution, and Notice** statements described in this document do not cover all the safety precautions. You also need to comply with relevant international, national, or regional standards and industry practices. **The Company shall not be liable for any consequences that may arise due to violations of safety requirements or safety standards concerning the design, production, and usage of the equipment.**

The equipment shall be used in an environment that meets the design specifications. Otherwise, the equipment may be faulty, malfunctioning, or damaged, which is not covered under the warranty. The Company shall not be liable for any property loss, personal injury, or even death caused thereby.

Comply with applicable laws, regulations, standards, and specifications during transportation, storage, installation, operation, use, and maintenance.

Do not perform reverse engineering, decompilation, disassembly, adaptation, implantation, or other derivative operations on the equipment software. Do not study the internal implementation logic of the equipment, obtain the source code of the equipment software, violate intellectual property rights, or disclose any of the performance test results of the equipment software.

The Company shall not be liable for any of the following circumstances or their consequences:

- The equipment is damaged due to force majeure such as earthquakes, floods, volcanic eruptions, debris flows, lightning strikes, fires, wars, armed conflicts, typhoons, hurricanes, tornadoes, and other extreme weather conditions.
- The equipment is operated beyond the conditions specified in this document.

- The equipment is installed or used in environments that do not comply with international, national, or regional standards.
- The equipment is installed or used by unqualified personnel.
- You fail to follow the operation instructions and safety precautions on the product and in the document.
- You remove or modify the product or modify the software code without authorization.
- You or a third party authorized by you cause the equipment damage during transportation.
- The equipment is damaged due to storage conditions that do not meet the requirements specified in the product document.
- You fail to prepare materials and tools that comply with local laws, regulations, and related standards.
- The equipment is damaged due to your or a third party's negligence, intentional breach, gross negligence, or improper operations, or other reasons not related to the Company.

1.1 Personal Safety

 **DANGER**

Ensure that power is off during installation. Do not install or remove a cable with power on. Transient contact between the core of the cable and the conductor will cause electric arcs, sparks, fire, or explosion, which may result in personal injury.

 **DANGER**

Non-standard and improper operations on the energized equipment may cause fire, electric shocks, or explosion, resulting in property damage, personal injury, or even death.

 **DANGER**

Before operations, remove conductive objects such as watches, bracelets, bangles, rings, and necklaces to prevent electric shocks.

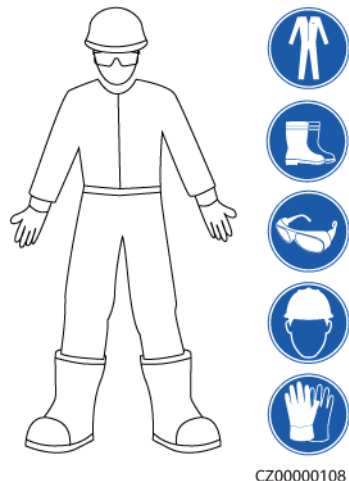
 **DANGER**

During operations, use dedicated insulated tools to prevent electric shocks or short circuits. The dielectric withstanding voltage level must comply with local laws, regulations, standards, and specifications.

⚠ DANGER

During operations, wear personal protective equipment such as protective clothing, insulated shoes, goggles, safety helmets, and insulated gloves.

Figure 1-1 Personal protective equipment



General Requirements

- Do not stop protective devices. Pay attention to the warnings, cautions, and related precautionary measures in this document and on the equipment.
- If there is a likelihood of personal injury or equipment damage during operations, immediately stop, report the case to the supervisor, and take feasible protective measures.
- Do not power on the equipment before it is installed or confirmed by professionals.
- Do not touch the power supply equipment directly or with conductors such as damp objects. Before touching any conductor surface or terminal, measure the voltage at the contact point to ensure that there is no risk of electric shock.
- Do not touch operating equipment because the enclosure is hot.
- In the case of a fire, immediately leave the building or the equipment area and activate the fire alarm or call emergency services. Do not enter the affected building or equipment area under any circumstances.

Personnel Requirements

- Only professionals and trained personnel are allowed to operate the equipment.
 - Professionals: personnel who are familiar with the working principles and structure of the equipment, trained or experienced in equipment operations and are clear of the sources and degree of various potential hazards in equipment installation, operation, maintenance
 - Trained personnel: personnel who are trained in technology and safety, have required experience, are aware of possible hazards on themselves in

certain operations, and are able to take protective measures to minimize the hazards on themselves and other people

- Personnel who plan to install or maintain the equipment must receive adequate training, be able to correctly perform all operations, and understand all necessary safety precautions and local relevant standards.
- Only qualified professionals or trained personnel are allowed to install, operate, and maintain the equipment.
- Only qualified professionals are allowed to remove safety facilities and inspect the equipment.
- Personnel who will perform special tasks such as electrical operations, working at heights, and operations of special equipment must possess the required local qualifications.
- Only authorized professionals are allowed to replace the equipment or components (including software).
- Only personnel who need to work on the equipment are allowed to access the equipment.

1.2 Electrical Safety

 **DANGER**

Before connecting cables, ensure that the equipment is intact. Otherwise, electric shocks or fire may occur.

 **DANGER**

Non-standard and improper operations may result in fire or electric shocks.

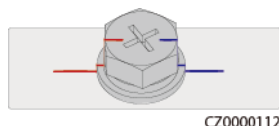
 **DANGER**

Prevent foreign matter from entering the equipment during operations. Otherwise, equipment short-circuits or damage, load power derating, power failure, or personal injury may occur.

General Requirements

- Follow the procedures described in the document for installation, operation, and maintenance. Do not reconstruct or alter the equipment, add components, or change the installation sequence without permission.
- Obtain approval from the national or local electric utility company before connecting the equipment to the grid.
- Observe the power plant safety regulations, such as the operation and work ticket mechanisms.
- Install temporary fences or warning ropes and hang "No Entry" signs around the operation area to keep unauthorized personnel away from the area.

- Before installing or removing power cables, turn off the switches of the equipment and its upstream and downstream switches.
- If any liquid is detected inside the equipment, disconnect the power supply immediately and do not use the equipment.
- Before performing operations on the equipment, check that all tools meet the requirements and record the tools. After the operations are complete, collect all of the tools to prevent them from being left inside the equipment.
- Before installing power cables, check that cable labels are correct and cable terminals are insulated.
- When installing the equipment, use a torque tool of a proper measurement range to tighten the screws. When using a wrench to tighten the screws, ensure that the wrench does not tilt and the torque error does not exceed 10% of the specified value.
- Ensure that bolts are tightened with a torque tool and marked in red and blue after double-check. Installation personnel mark tightened bolts in blue. Quality inspection personnel confirm that the bolts are tightened and then mark them in red. (The marks must cross the edges of the bolts.)



- After the installation is complete, ensure that protective cases, insulation tubes, and other necessary items for all electrical components are in position to avoid electric shocks.
- If the equipment has multiple inputs, disconnect all the inputs and wait until the equipment is completely powered off before performing operations on the equipment.
- Before maintaining a downstream electrical or power distribution device, turn off the output switch on the power supply equipment.
- During equipment maintenance, attach "Do not switch on" labels near the upstream and downstream switches or circuit breakers as well as warning signs to prevent accidental connection. The equipment can be powered on only after troubleshooting is complete.
- If fault diagnosis and troubleshooting need to be performed after power-off, take the following safety measures: Disconnect the power supply. Check whether the equipment is live. Install a ground cable. Hang warning signs and set up fences.
- Do not open equipment panels.
- Check equipment connections periodically, ensuring that all screws are securely tightened.
- Only qualified professionals can replace a damaged cable.
- Do not scrawl, damage, or block any labels or nameplates on the equipment. Promptly replace labels that have worn out.
- Do not use solvents such as water, alcohol, or oil to clean electrical components inside or outside of the equipment.
- Do not cut off the cables delivered with the optimizer, as this will void the warranty.

- The output wiring terminals of the optimizer are not hot-swappable. If the terminals are hot-swapped, the optimizer may be damaged.

Lightning Protection


The building where a rooftop PV power system is located shall have basic lightning protection capabilities, including an air-termination system (lightning conductor strip), down-conductor system, and earth-termination system. Do not install or use the PV system at a site without lightning protection or when the building's lightning protection system does not cover the PV array. This prevents damage to the PV electrical system and electronic system caused by lightning surge and lightning induction.

- The PV system shall be equipped with an air-termination system, equipotential bonding strips, down-conductor system, and earth-termination system. Do not use metal frames or equipotential bonding strips of PV modules as the air-termination system.
- The metal support of the PV system must be reliably grounded. The metal support and the equipotential bonding strips shall be connected to form a mesh with a spacing of 3 m to 10 m. The edge of the equipotential bonding strips shall be connected to the nearest lightning conductor strips at multiple points with a spacing of 3 m to 10 m.
- The metal frames of PV modules shall be reliably connected to the metal support through grounding piercing washers.
- The grounding resistance of the PV system shall meet the grounding protection requirements of electrical devices.

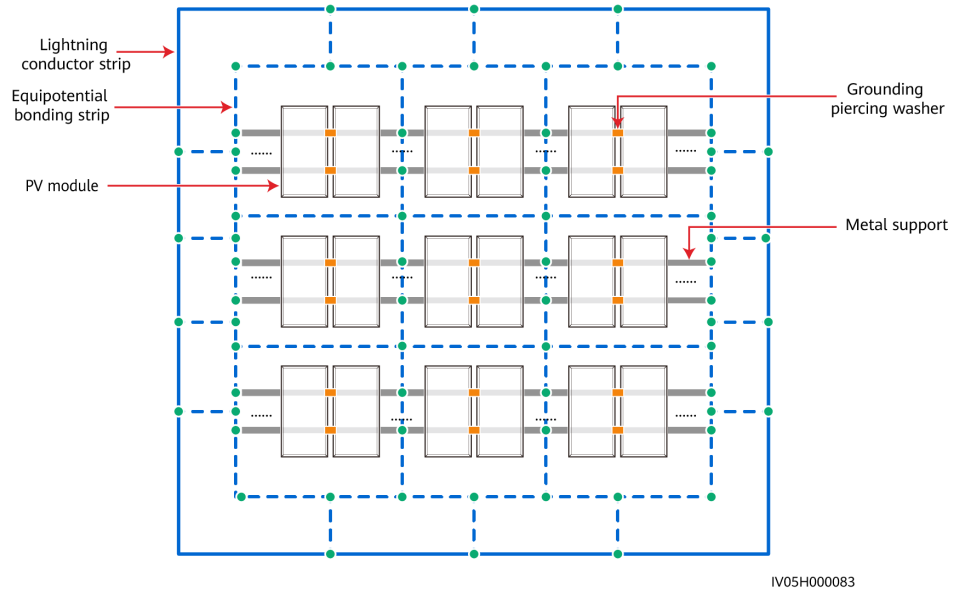
NOTE

- Lightning conductor strip: A lightning conductor strip, along with a lightning rod, forms the air-termination system. Its purpose is to channel the lightning current and direct it into the ground via the down-conductor system.
- Equipotential bonding strip: An equipotential bonding strip is a metal strip that connects metal devices, external conductive objects, power lines, telecommunications lines, and other lines to surge protection devices for equipotential bonding.

NOTICE

 PV module frames have an anodized film. Pierce through the anodized film using grounding piercing washers to ensure secure electrical connections between supports and PV module frames.

 Ensure good contact between lightning conductor strips and equipotential bonding strips and between equipotential bonding strips and metal supports.



Cabling Requirements

- When selecting, installing, and routing cables, follow local safety regulations and rules.
- When routing power cables, ensure that there is no coiling or twisting. Do not join or weld power cables. If necessary, use a longer cable.
- Ensure that all cables are properly connected and insulated, and meet specifications.
- Ensure that the slots and holes for routing cables are free from sharp edges, and that the positions where cables are routed through pipes or cable holes are equipped with cushion materials to prevent the cables from being damaged by sharp edges or burrs.
- Ensure that cables of the same type are bound together neatly and straight and that the cable sheath is intact. When routing cables of different types, ensure that they are away from each other without entanglement and overlapping.
- When cable connection is completed or paused for a short period of time, seal the cable holes with sealing putty immediately to prevent small animals or moisture from entering.
- Secure buried cables using cable supports and cable clips. Ensure that the cables in the backfill area are in close contact with the ground to prevent cable deformation or damage during backfilling.
- If the external conditions (such as the cable layout or ambient temperature) change, verify the cable usage in accordance with the IEC-60364-5-52 or local laws and regulations. For example, check that the current-carrying capacity meets requirements.
- When routing cables, reserve at least 30 mm clearance between the cables and heat-generating components or areas. This prevents deterioration or damage to the cable insulation layer.
- When the temperature is low, violent impact or vibration may damage the plastic cable sheathing. To ensure safety, comply with the following requirements:

- Cables can be laid or installed only when the temperature is higher than 0°C. Handle cables with caution, especially at a low temperature.
- Cables stored at below 0°C must be stored at room temperature for more than 24 hours before they are laid out.
- Do not perform any improper operations, for example, dropping cables directly from a vehicle. Otherwise, the cable performance may deteriorate due to cable damage, which affects the current-carrying capacity and temperature rise.

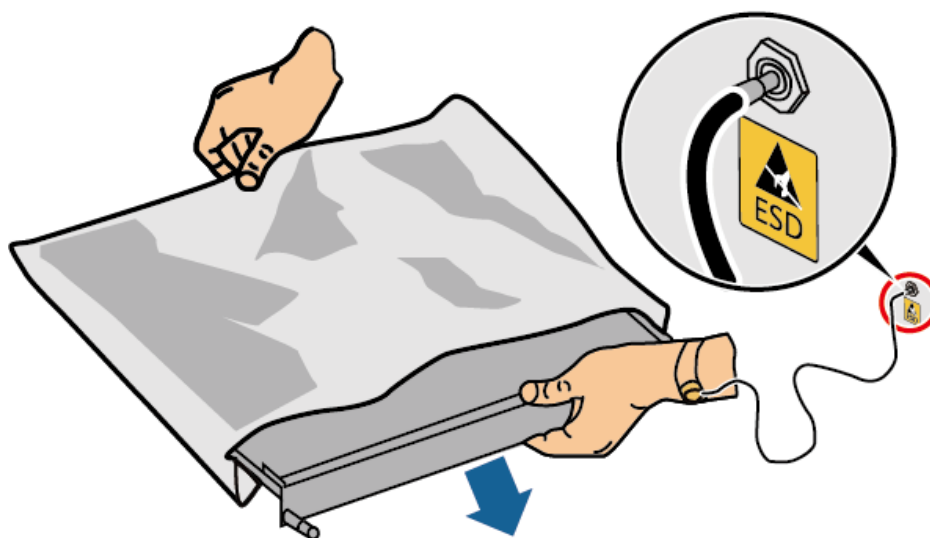
ESD

NOTICE

The static electricity generated by human bodies may damage the electrostatic-sensitive components on boards, for example, the large-scale integrated (LSI) circuits.

- When touching the equipment and handling boards, modules with exposed circuit boards, or application-specific integrated circuits (ASICs), observe ESD protection regulations and wear ESD clothing and ESD gloves or a well-grounded ESD wrist strap.

Figure 1-2 Wearing an ESD wrist strap



DC1500001

- When holding a board or a module with exposed circuit boards, hold its edge without touching any components. Do not touch the components with bare hands.
- Package boards or modules with ESD packaging materials before storing or transporting them.

1.3 Environment Requirements

 **DANGER**

Do not expose the equipment to flammable or explosive gas or smoke. Do not perform any operation on the equipment in such environments.

 **DANGER**

Do not store any flammable or explosive materials in the equipment area.

 **DANGER**

Do not place the equipment near heat sources or fire sources, such as smoke, candles, heaters, or other heating devices. Overheat may damage the equipment or cause a fire.

 **WARNING**

Install the equipment in an area far away from liquids. Do not install it under areas prone to condensation, such as under water pipes and air exhaust vents, or areas prone to water leakage, such as air conditioner vents, ventilation vents, or feeder windows of the equipment room. Ensure that no liquid enters the equipment to prevent faults or short circuits.

 **WARNING**

To prevent damage or fire due to high temperature, ensure that the ventilation vents or heat dissipation systems are not obstructed or covered by other objects while the equipment is running.

General Requirements

- Ensure that the equipment is stored in a clean, dry, and well ventilated area with proper temperature and humidity and is protected from dust and condensation.
- Keep the installation and operating environments of the equipment within the allowed ranges. Otherwise, its performance and safety will be compromised.
- Do not install, use, or operate outdoor equipment and cables (including but not limited to moving equipment, operating equipment and cables, inserting connectors to or removing connectors from signal ports connected to outdoor facilities, working at heights, performing outdoor installation, and opening

doors) in harsh weather conditions such as lightning, rain, snow, and level 6 or stronger wind.

- Do not install the equipment in an environment with direct sunlight, dust, smoke, volatile or corrosive gases, infrared and other radiations, organic solvents, or salty air.
- Do not install the equipment in an environment with conductive metal or magnetic dust.
- Do not install the equipment in an area conducive to the growth of microorganisms such as fungus or mildew.
- Do not install the equipment in an area with strong vibration, noise, or electromagnetic interference.
- Ensure that the site complies with local laws, regulations, and related standards.
- Ensure that the ground in the installation environment is solid, free from spongy or soft soil, and not prone to subsidence. The site must not be located in a low-lying land prone to water or snow accumulation, and the horizontal level of the site must be above the highest water level of that area in history.
- Do not install the equipment in a position that may be submerged in water.
- If the equipment is installed in a place with abundant vegetation, in addition to routine weeding, harden the ground underneath the equipment using cement or gravel.
- Do not install the equipment outdoors in salt-affected areas because it may be corroded. A salt-affected area refers to the region within 500 m of the coast or prone to sea breeze. Regions prone to sea breeze vary with weather conditions (such as typhoons and monsoons) or terrains (such as dams and hills).
- Before installation, operation, and maintenance, clean up any water, ice, snow, or other foreign objects on the top of the equipment.
- When installing the equipment, ensure that the installation surface is solid enough to bear the weight of the equipment.
- After installing the equipment, remove the packing materials such as cartons, foam, plastics, and cable ties from the equipment area.

1.4 Mechanical Safety

 **DANGER**

When working at heights, wear a safety helmet and safety harness or waist belt and fasten it to a solid structure. Do not mount it on an insecure moveable object or metal object with sharp edges. Make sure that the hooks will not slide off.

 **WARNING**

Ensure that all necessary tools are ready and inspected by a professional organization. Do not use tools that have signs of scratches or fail to pass the inspection or whose inspection validity period has expired. Ensure that the tools are secure and not overloaded.

 **WARNING**

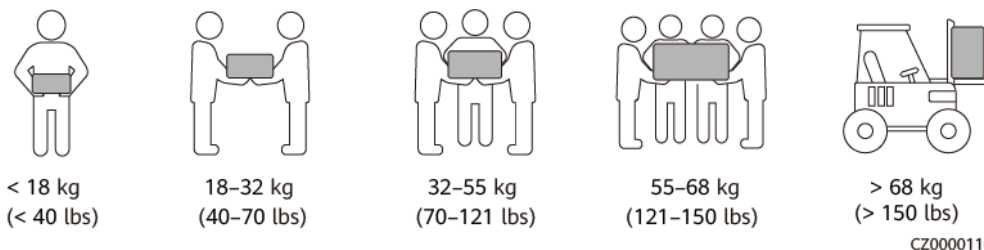
Do not drill holes into the equipment. Doing so may affect the sealing performance and electromagnetic containment of the equipment and damage components or cables inside. Metal shavings from drilling may short-circuit boards inside the equipment.

General Requirements

- Repaint any paint scratches caused during equipment transportation or installation in a timely manner. Equipment with scratches must not be exposed for an extended period of time.
- Do not perform operations such as arc welding and cutting on the equipment without evaluation by the Company.
- Do not install other devices on the top of the equipment without evaluation by the Company.
- When performing operations over the top of the equipment, take measures to protect the equipment against damage.
- Use correct tools and operate them in the correct way.

Moving Heavy Objects

- Be cautious to prevent injury when moving heavy objects.



- If multiple persons need to move a heavy object together, determine the manpower and work division with consideration of height and other conditions to ensure that the weight is equally distributed.
- If two persons or more move a heavy object together, ensure that the object is lifted and landed simultaneously and moved at a uniform pace under the supervision of one person.
- Wear personal protective gears such as protective gloves and shoes when manually moving the equipment.
- To move an object by hand, approach to the object, squat down, and then lift the object gently and stably by the force of the legs instead of your back. Do not lift it suddenly or turn your body around.

- Do not quickly lift a heavy object above your waist. Place the object on a workbench that is half-waist high or any other appropriate place, adjust the positions of your palms, and then lift it.
- Move a heavy object stably with balanced force at an even and low speed. Put down the object stably and slowly to prevent any collision or drop from scratching the surface of the equipment or damaging the components and cables.
- When moving a heavy object, be aware of the workbench, slope, staircase, and slippery places. When moving a heavy object through a door, ensure that the door is wide enough to move the object and avoid bumping or injury.
- When transferring a heavy object, move your feet instead of turning your waist around. When lifting and transferring a heavy object, ensure that your feet point to the target direction of movement.
- When transporting the equipment using a pallet truck or forklift, ensure that the tynes are properly positioned so that the equipment does not topple. Before moving the equipment, secure it to the pallet truck or forklift using ropes. When moving the equipment, assign dedicated personnel to take care of it.
- Choose sea or roads in good conditions for transportation. Do not transport the equipment by railway or air. Avoid tilt or jolt during transportation.

Working at Heights

- Any operations performed 2 m or higher above the ground shall be supervised properly.
- Only trained and qualified personnel are allowed to work at heights.
- Do not work at heights when steel pipes are wet or other risky situations exist. After the preceding conditions no longer exist, the safety owner and relevant technical personnel need to check the involved equipment. Operators can begin working only after safety is confirmed.
- Set a restricted area and prominent signs for working at heights to warn away irrelevant personnel.
- Set guard rails and warning signs at the edges and openings of the area involving working at heights to prevent falls.
- Do not pile up scaffolding, springboards, or other objects on the ground under the area involving working at heights. Do not allow people to stay or pass under the area involving working at heights.
- Carry operation machines and tools properly to prevent equipment damage or personal injury caused by falling objects.
- Personnel involving working at heights are not allowed to throw objects from the height to the ground, or vice versa. Objects shall be transported by slings, hanging baskets, aerial work platforms, or cranes.
- Do not perform operations on the upper and lower layers at the same time. If unavoidable, install a dedicated protective shelter between the upper and lower layers or take other protective measures. Do not pile up tools or materials on the upper layer.
- Dismantle the scaffolding from top down after finishing the job. Do not dismantle the upper and lower layers at the same time. When removing a part, ensure that other parts will not collapse.

- Ensure that personnel working at heights strictly comply with the safety regulations. The Company is not responsible for any accident caused by violation of the safety regulations on working at heights.
- Behave cautiously when working at heights. Do not rest at heights.

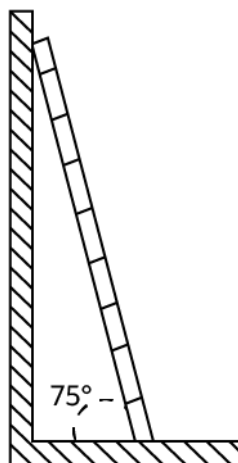
Using Ladders

- Use wooden or insulated ladders when you need to perform live-line working at heights.
- Platform ladders with protective rails are preferred. Single ladders are not recommended.
- Before using a ladder, check that it is intact and confirm its load bearing capacity. Do not overload it.
- Ensure that the ladder is securely positioned and held firm.



CZ00000107

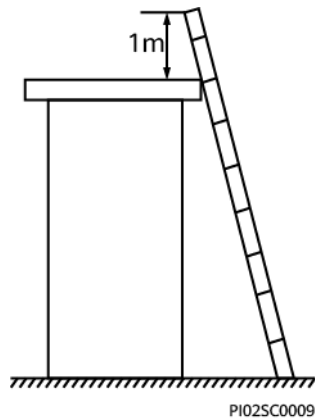
- When climbing up the ladder, keep your body stable and your center of gravity between the side rails, and do not overreach to the sides.
- When a step ladder is used, ensure that the pull ropes are secured.
- If a single ladder is used, the recommended angle for the ladder against the floor is 75 degrees, as shown in the following figure. A square can be used to measure the angle.



PI025C0008

- If a single ladder is used, ensure that the wider end of the ladder is at the bottom, and take protective measures to prevent the ladder from sliding.
- If a single ladder is used, do not climb higher than the fourth rung of the ladder from the top.

- If you use a single ladder to climb up to a platform, ensure that the ladder is at least 1 m higher than the platform.



Drilling Holes

- Obtain consent from the customer and contractor before drilling holes.
- Wear protective equipment such as safety goggles and protective gloves when drilling holes.
- To avoid short circuits or other risks, do not drill holes into buried pipes or cables.
- When drilling holes, protect the equipment from shavings. After drilling, clean up any shavings.

2 Product Overview

The Smart PV Optimizer is a DC to DC converter which implements maximum power point tracking (MPPT) of each PV module to improve the energy yield of the PV system. It enables module-level shutdown and monitoring, and supports long-string design.

2.1 Model Number Description

This document involves the following product model:

- MERC-600W-PA0

Figure 2-1 Model number

MERC-600W-PA0

1

2

3

IH11W00002

(1) Product series
name

(2) Rated input power:
600 W

(3) PV optimizer

Scenario	Optimizer Model	Rated Input Power	Input Cable Length	Output Cable Length
Residential optimizer	MERC-600W-PA0	600 W	100 mm (positive) + 100 mm (negative)	2225 mm (positive) + 100 mm (negative)

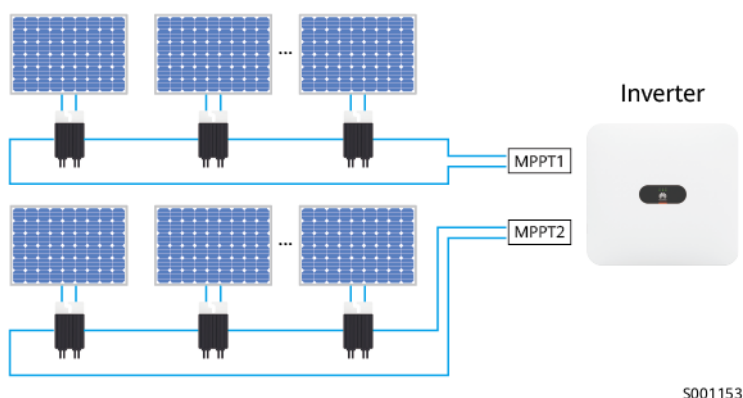
2.2 Overview

Application Scenarios

 NOTE

- To ensure that optimizers are successfully connected to PV modules, select PV modules whose output power cables meet the length requirements.
- To minimize electromagnetic interference, minimize the distance between the positive and negative cables of an optimizer.
- To ensure reliable communication between the inverter and optimizer, the AC and DC power cables of the inverter must be more than 10 cm away from the AC power cables of motor-type impact loads, such as air conditioners and elevators. It is recommended that the cables be routed in different troughs or pipes.
- Prevent backfeeding from an external power supply or a PV string not equipped with optimizers to PV strings equipped with optimizers. Otherwise, the optimizers will fail.
- Scenario 1: Optimizers are configured for all PV modules connected to an inverter.

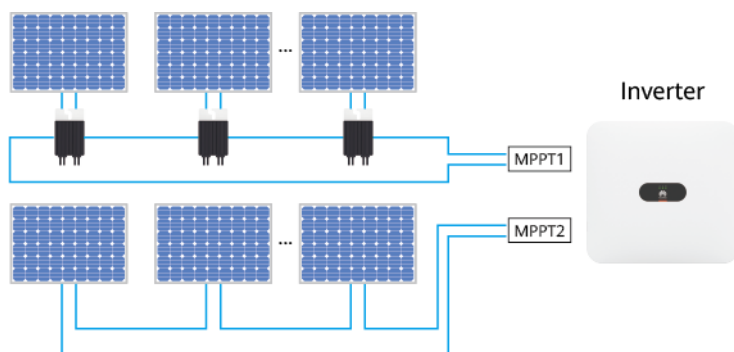
Figure 2-2 Application scenario (optimizers configured for all PV modules connected to an inverter)



S001153

- Scenario 2: Optimizers are configured for all PV modules connected to some of MPPTs of an inverter.

Figure 2-3 Application scenario (optimizers configured for all PV modules connected to an MPPT)



S001154

Functions and Features

Function	Scenario 1: Optimizers Configured for All PV Modules Connected to an Inverter	Scenario 2: Optimizers Configured for All PV Modules Connected to an MPPT
Module-level MPPT	√	√
Module-level monitoring	√	√
Rapid shutdown	√	×
DC terminal overtemperature protection	√	×
Module-level diagnosis	√	×
Disconnection detection	√	×
Long PV string	√	×

- **Module-level MPPT:** Implements maximum power point tracking of each PV module to improve the energy yield of the PV system.
- **Module-level monitoring:** Monitors the operating status of each PV module.
- **Rapid shutdown:** Adjusts the module output voltage to a safe range when the output is disconnected or the inverter shuts down, ensuring the safety of construction and O&M personnel as well as firefighters.
- **DC terminal overtemperature protection:** Protects optimizers connected with short input and output cables if DC terminal overtemperature occurs.

NOTE

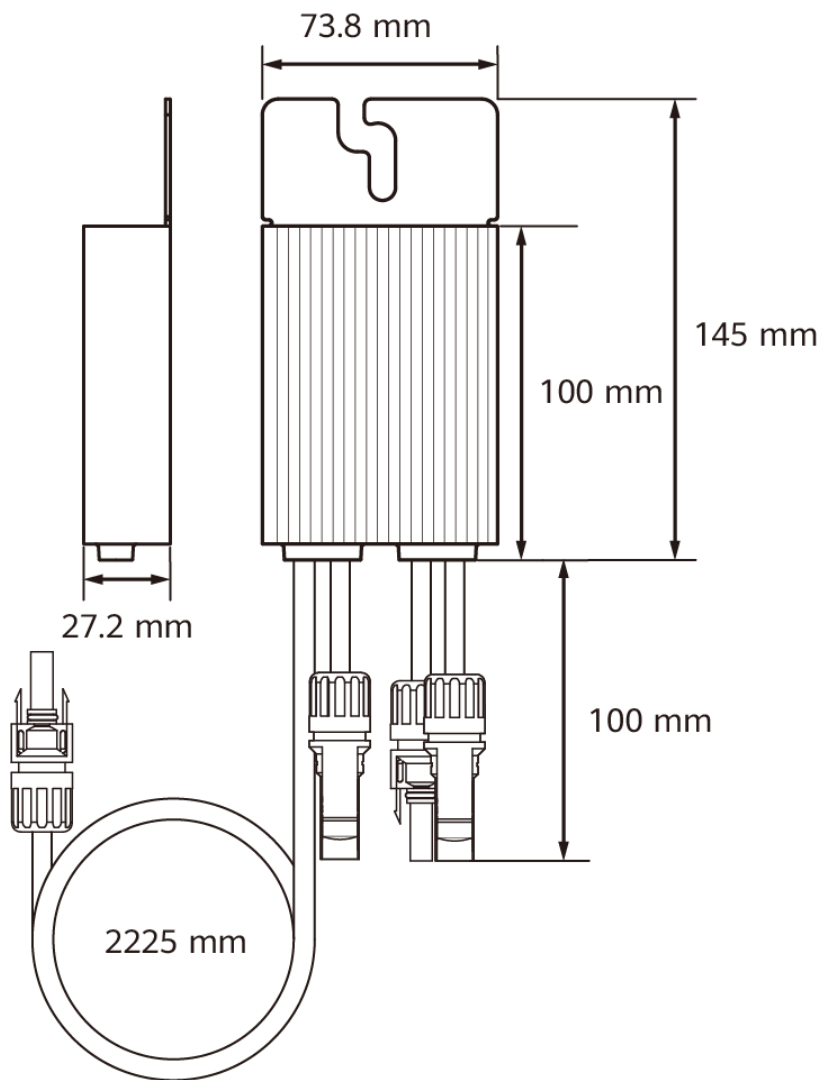
- DC terminal overtemperature protection is not supported in the SmartLogger scenario.
- **Module-level diagnosis:** Identifies PV module faults in a timely manner.
- **Disconnection detection:** Performs disconnection detection on optimizers and locates the disconnected ones.

- Long PV string: Contains more PV modules than a conventional PV string. The optimizer's voltage limiting function ensures that the DC voltage between any two live conductors or between a live conductor and the ground does not exceed 600 V (single-phase) or 1000 V (three-phase).

2.3 Structure

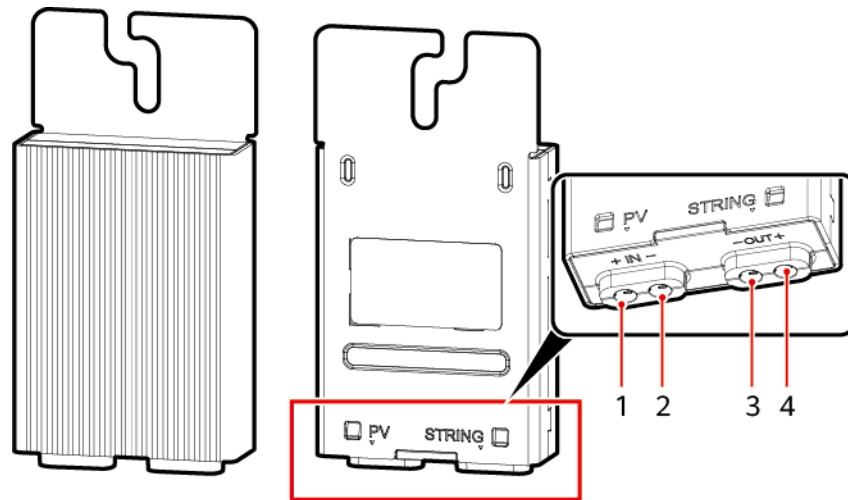
Optimizer Dimensions

Figure 2-4 MERC-600W-PA0 dimensions



Optimizer Ports

Figure 2-5 Ports



- (1) Input port (positive)
- (3) Output port (negative)

- (2) Input port (negative)
- (4) Output port (positive)

2.4 Configuration Principles

The optimizer models supported by different inverter models may vary, and the same inverter may be configured with different optimizer models. Consider compatibility and select appropriate optimizer models as required.

Principles for Configuring Optimizers for All PV Modules Connected to an Inverter or MPPT

The number of optimizers supported in a PV string, the upper limit of the string power, and requirements for connecting PV strings in parallel vary according to the inverter model. The configuration principles for different inverter models are as follows:

NOTICE

- Configuration principle for scenario 1: Optimizers shall be configured for all PV modules connected to an inverter.
- Configuration principle for scenario 2:
 - Optimizers shall be configured for all PV modules connected to some of MPPTs of an inverter.
 - The maximum number of PV modules connected in series in a PV string must be calculated according to the requirements of relevant regulations. The open-circuit voltage at the estimated lowest local temperature must meet the following requirements: 1. The open-circuit voltage must not exceed the maximum input voltage of the inverter. 2. The open-circuit voltage must not exceed 600 V for a single-phase inverter or 1000 V for a three-phase inverter.
- The system configured with optimizers does not support thin-film PV modules or lightweight PV modules.

 **NOTE**

1. If two strings are connected in parallel to the same MPPT, the constraints for configuring optimizers are as follows:
 - PV strings connected to the same MPPT must use the same quantity of PV modules of the same model and the same quantity of optimizers.
 - All PV modules in the same PV string must have the same orientation and tilt angle. The orientations and tilt angles of two PV strings can be different.
2. If only one PV string is connected to an MPPT and optimizers are configured, PV modules of different models can be used in the PV string, and the orientations and tilt angles of the PV modules can be different.
3. You are advised to use the design of long strings instead of Y-branch connectors.

Table 2-1 Mapping between inverters and optimizers

Supported Inverter Model	Number of Optimizers Supported in a String	String Power Upper Limit	Version
SUN5000-8/12K-MAP0	6–35	12 kW	SUN2000MA V200R024C00SPC 108 or later
SUN5000-17/25K-MB0	6–35	12 kW ^a	SUN2000MB V200R023C10SPC 213 or later
SUN5000-4.95K-LB0-NH	6–20	5 kW	SUN2000LB V300R024C10SPC 106 or later
SUN2000-4.95K-LB0-NH	6–20	5 kW	SUN2000LB V300R024C10SPC 106 or later

Supported Inverter Model	Number of Optimizers Supported in a String	String Power Upper Limit	Version
SUN5000-3K/6K-LB0	4-20	6 kW	SUN2000LB V300R024C00SPC 108 or later
SUN2000-4.95KTL-NHL2	4-20	6 kW	SUN2000L V200R001C00SPC 153 or later
SUN2000-2/3/3.68/4/4.6/5/6KTL-L1	4-20	6 kW	SUN2000L V200R001C00SPC 153 or later
SUN2000-3K/3.68K/4K/4.6K/5K/6K-LB0	4-20	6 kW	SUN2000LB V300R024C00SPC 108 or later
SUN2000-8/10K-LC0	4-20	6 kW	SUN2000LC V100R023C10SPC 113 or later
SUN2000-3/4/5/6/8/10KTL-M1	6-35	10 kW	SUN2000MA V100R001C00SPC 174 or later
SUN2000-10KTL-BEM1	6-35	10 kW	SUN2000MA V100R001C00SPC 174 or later
SUN2000-5/6/8/10/12K-MAP0	6-35	12 kW	SUN2000MA V200R024C00SPC 108 or later
SUN2000-10K-MAP0-BE	6-35	12 kW	SUN2000MA V200R024C00SPC 108 or later
SUN2000-12/15/17/20/25K-MB0	6-35	12 kW ^a	SUN2000MB V200R023C10SPC 213 or later
<p>Note a: The power difference between PV strings connected to the same inverter shall be ≤ 2 kW. Otherwise, issues such as DC power limiting or inverter derating may occur, which will cause a decrease in energy yield.</p>			

Compatibility Between Optimizers

NOTE

"√" indicates mixed use supported. "×" indicates mixed use not supported.

Table 2-2 Optimizer compatibility

Optimizer Compatibility	MERC-600W-PA0
SUN2000P-375W	×
SUN2000-450W-P	×
SUN2000-450W-P2	×
SUN2000-600W-P	×
MERC-600W-PA0	√

 **NOTE**

Residential optimizers and C&I optimizers cannot be used together.

3 Installation and Commissioning

This section describes how to install the MERC-600W-PA0.

NOTICE

Before the equipment is put into operation for the first time, ensure that the parameters are set correctly by professional personnel. Incorrect parameter settings may result in noncompliance with local grid connection requirements and affect the normal operations of the equipment.

3.1 Precautions

- The DC connector model of the optimizer is Staubli MC4. Ensure that the DC connectors are of the same model. Otherwise, the connector compatibility report and third-party lab (TUV, VED, or Bureau Veritas) report from the DC connector manufacturer must be provided. Using incompatible DC connectors may result in serious consequences. The resulting device damage is beyond the warranty scope.
- If the optimizer does not connect to any other device, protect it from rain.
- It is recommended that the positive and negative cables (PV+/PV-) between the optimizer and inverter be placed in parallel to avoid cable tangling.
- The input power cable of the optimizer is connected to the PV module junction box, and the output power cable is connected to the adjacent optimizer or inverter. Do not reversely connect the input and output power cables. Otherwise, the optimizer may be damaged.
- The optimizer is a class II device and thus does not need to be grounded.
- If optimizers are configured for all PV modules connected to an inverter, deployment can be performed only when the power grid is available.
- If optimizers are configured for all PV modules connected to an inverter, operation only in off-grid mode is not supported.
- If optimizers are configured for all PV modules connected to an inverter, operation in on/off-grid scenarios is as follows:
 - a. If no batteries are configured: After the grid fails, the system automatically switches to the off-grid mode and is powered off at night

because no batteries are configured. If the grid does not recover on the next day, the system cannot automatically start when the irradiance is normal. After the grid recovers, the system automatically detects the grid and resumes normal operation.

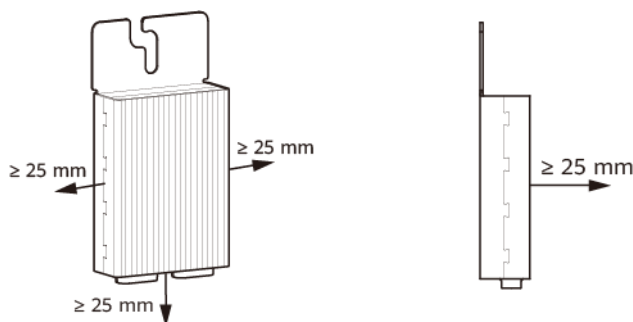
- b. If batteries are configured: After the grid fails, the system automatically switches to the off-grid mode. If the SOC is 5% or higher after discharge at night, the system can be black-started using batteries when the irradiance is normal. If the SOC is less than 5%, the system can be restarted and automatically resume normal operation only after the grid recovers.

3.2 Installation Requirements

- Clearance requirements

You are advised to reserve appropriate clearances around the optimizer for installation and heat dissipation.

Figure 3-1 Clearance requirements



- If optimizers and PV modules are installed close to the rooftop (for example, color steel tile rooftop), ensure that the optimizers are well ventilated. It is recommended that the ambient temperature be less than or equal to 70°C. If the ambient temperature exceeds 70°C, the optimizers may shut down for overtemperature protection. After the operating temperature decreases, the optimizers automatically recover with no risk of damage.
- Properly plan the optimizer installation positions. Ensure that the cables between the optimizers and PV modules and between adjacent optimizers can be properly connected. The maximum communication distance between the optimizers and the inverters is 350 m.

3.3 Installing the Device

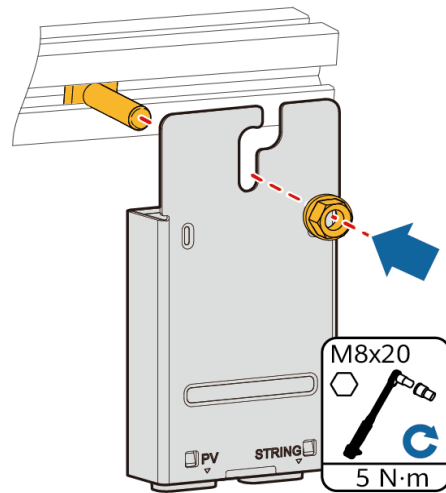
Step 1 Install the optimizer.

- Method 1: Install the optimizer to the extruded aluminum profile using a T-shaped bolt.

NOTE

The T-shaped bolt and nut should be purchased from the Company.

Figure 3-2 Installing the optimizer to the extruded aluminum profile with a T-shaped bolt

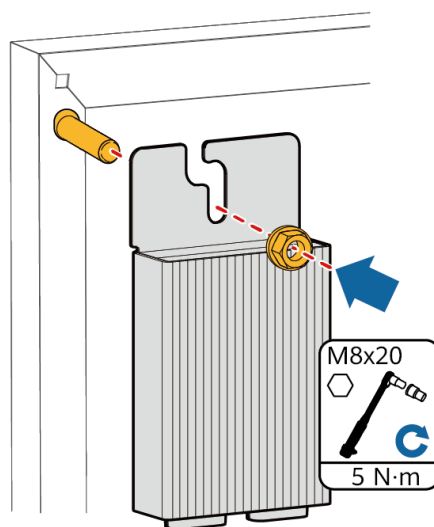


- Method 2: Install the optimizer to the PV module frame using a bolt assembly.

NOTE

- Before installation, ensure that a mounting hole is reserved on the PV module frame.
- The bolt assembly and nut should be purchased from a third party. The length of bolt assembly and nut must meet the requirements for installing the optimizer on the PV module frame.

Figure 3-3 Installing the optimizer to the PV module frame with a bolt assembly

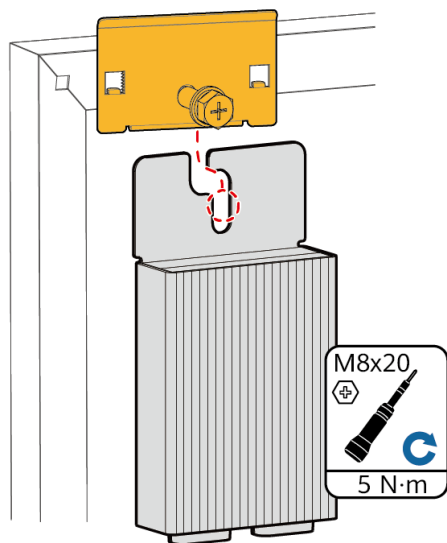


- Method 3: Install the optimizer to the PV module frame using a frame mounting bracket (front installation).

 NOTE

- Before installation, remove the QR code from the rear of the optimizer and attach it to the physical layout template.
- Do not press the optimizer mounting ear against the positioning pole of the frame mounting bracket.
- The frame mounting bracket should be purchased from the Company.

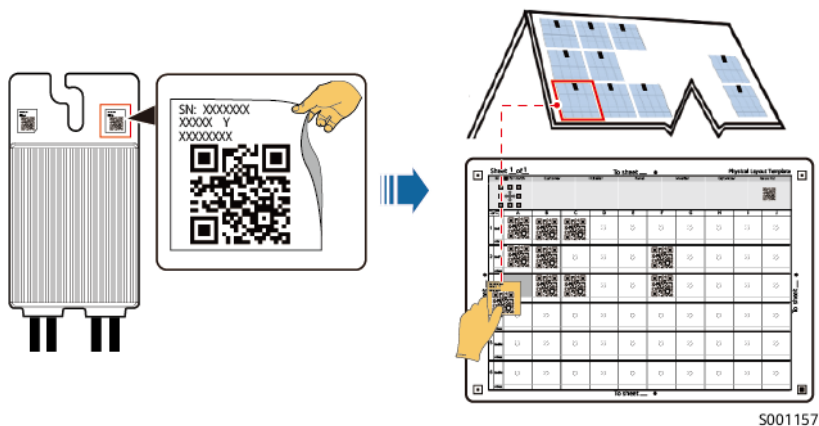
Figure 3-4 Installing the optimizer to the PV module frame with a frame mounting bracket (front installation)



Step 2 Determine the optimizer position.

- Optimizers configured for all PV modules connected to an inverter: After determining the optimizer installation position, remove the SN label from each optimizer and attach the SN label to the corresponding position on the physical layout template based on the actual position of the optimizer. For details, see the instructions on the rear side of the *Physical Layout Template* delivered with the optimizers.

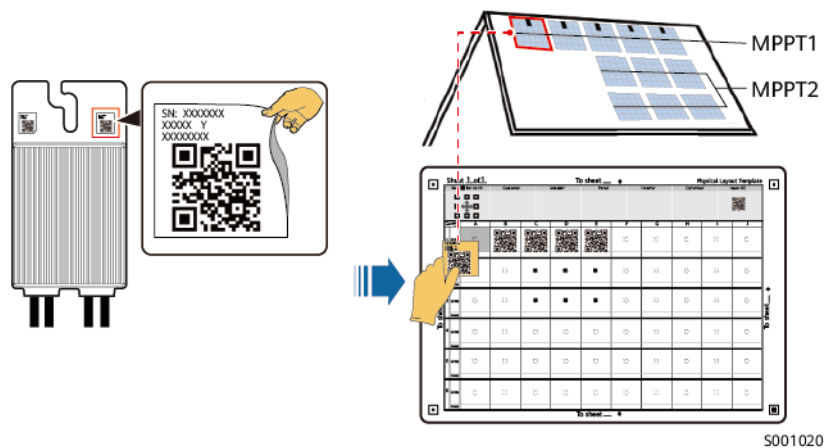
Figure 3-5 Removing the label and attaching it to the physical layout template (optimizers configured for all PV modules connected to an inverter)



S001157

- Optimizers configured for all PV modules connected to an MPPT: If PV modules are installed and optimizers are configured, remove the SN label from each optimizer and attach the SN label to the corresponding position on the physical layout template based on the actual position of the optimizer. If PV modules are installed but optimizers are not configured, paint black the dotted boxes in the corresponding cells on the physical layout template based on the actual positions of the PV modules. For details, see the instructions on the rear side of the *Physical Layout Template* delivered with the optimizers.

Figure 3-6 Removing the label and attaching it to the physical layout template (optimizers configured for all PV modules connected to an MPPT)



----End

3.4 Connecting Cables

NOTICE

- Ensure that the input (IN) and output (OUT) power cables of the optimizer are correctly connected. If they are reversely connected, the device will be damaged.
- Do not use an extension cable between the optimizer input and the PV module.

Step 1 After checking that the optimizer output power cables are properly connected, connect the optimizer input power cables. Use a multimeter to measure PV string voltages when the irradiance is adequate. The voltage of each PV module shall be 1 V ($\pm 5\%$), and the voltage value ($\pm 5\%$) of the PV string shall be equal to the number of optimizers in the string. If the probes are reversely connected, the voltages measured are negative values.

NOTE

PV string voltage = $V1 + V2 + \dots + VN \approx N \times 1 \text{ V}$

- When optimizers are connected to PV modules, the output voltage of each optimizer shall be 1 V ($\pm 5\%$). Therefore, the voltage of the PV string is approximately equal to the number of optimizers.
- If the voltage of the PV string is abnormal, separately measure the voltage of each optimizer connected to PV modules. For the troubleshooting instructions, see [6.1 How Do I Identify a Faulty Optimizer by Measuring the Voltage?](#)

Figure 3-7 Measuring the PV string voltage

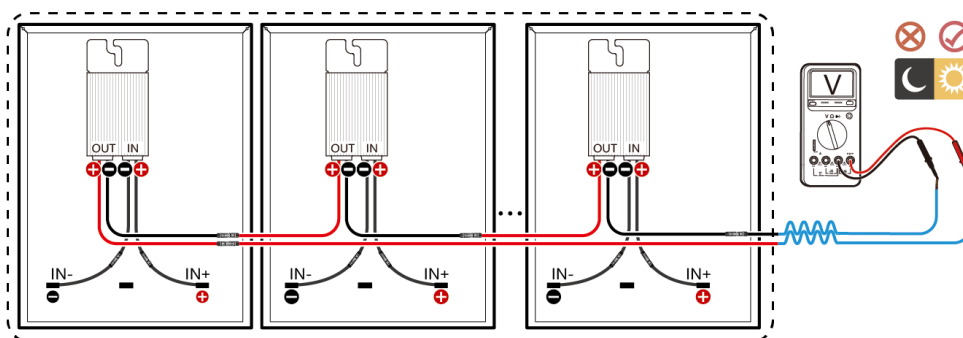


Table 3-1 Checklist for abnormal PV string voltage

Checklist for Abnormal PV String Voltage		
Symptom	Possible Cause	Suggestion
The PV string voltage is about 0.	The PV string is open-circuited.	Check whether the PV string is open-circuited.
	The positive and negative cables are not connected to the same PV string.	Identify the positive and negative cables correctly in the PV string.
The PV string voltage is a negative value.	The positive and negative terminals of the PV string cables are incorrect.	Correctly prepare positive and negative terminals of the PV string cables.

Checklist for Abnormal PV String Voltage		
Symptom	Possible Cause	Suggestion
The value of PV string voltage is less than the number of optimizers.	1. Some optimizer input power cables are not connected to PV modules. 2. Some optimizer output power cables are not connected to PV strings. 3. Some optimizer output power cables are reversely connected.	1. Check whether cables between optimizers and PV modules and between optimizers are properly connected. 2. If yes, check all extension cables to ensure that a positive connector and a negative connector are on both ends of each extension cable, respectively.
	The actual number of optimizers in PV strings is less than the designed number.	Check whether the number of optimizers in PV strings is correct.
The value of PV string voltage is greater than the number of optimizers.	PV modules are not connected to optimizers but directly connected to PV strings.	All PV modules must be connected to optimizers. Check whether the cables between optimizers and PV modules and between optimizers are correctly connected.
	The actual number of optimizers in PV strings is greater than the designed number.	Check whether the number of optimizers in PV strings is correct.

Step 2 Connect cables between the PV string and the inverter.

 **NOTE**

- To ensure reliable communication between the inverter and optimizer, route DC and AC power cables in different troughs with a spacing of more than 10 cm.
- For details about the configuration of optimizers connected to PV strings and inverters, see [2.4 Configuration Principles](#). Incorrect configurations may cause an optimizer or inverter failure.
- To reduce the impact of electromagnetic interference, it is recommended that the distance (D) between the positive and negative cables of optimizers be minimized, as shown in the following figure for either a single-string installation or a multi-string installation.

Figure 3-8 Required cabling

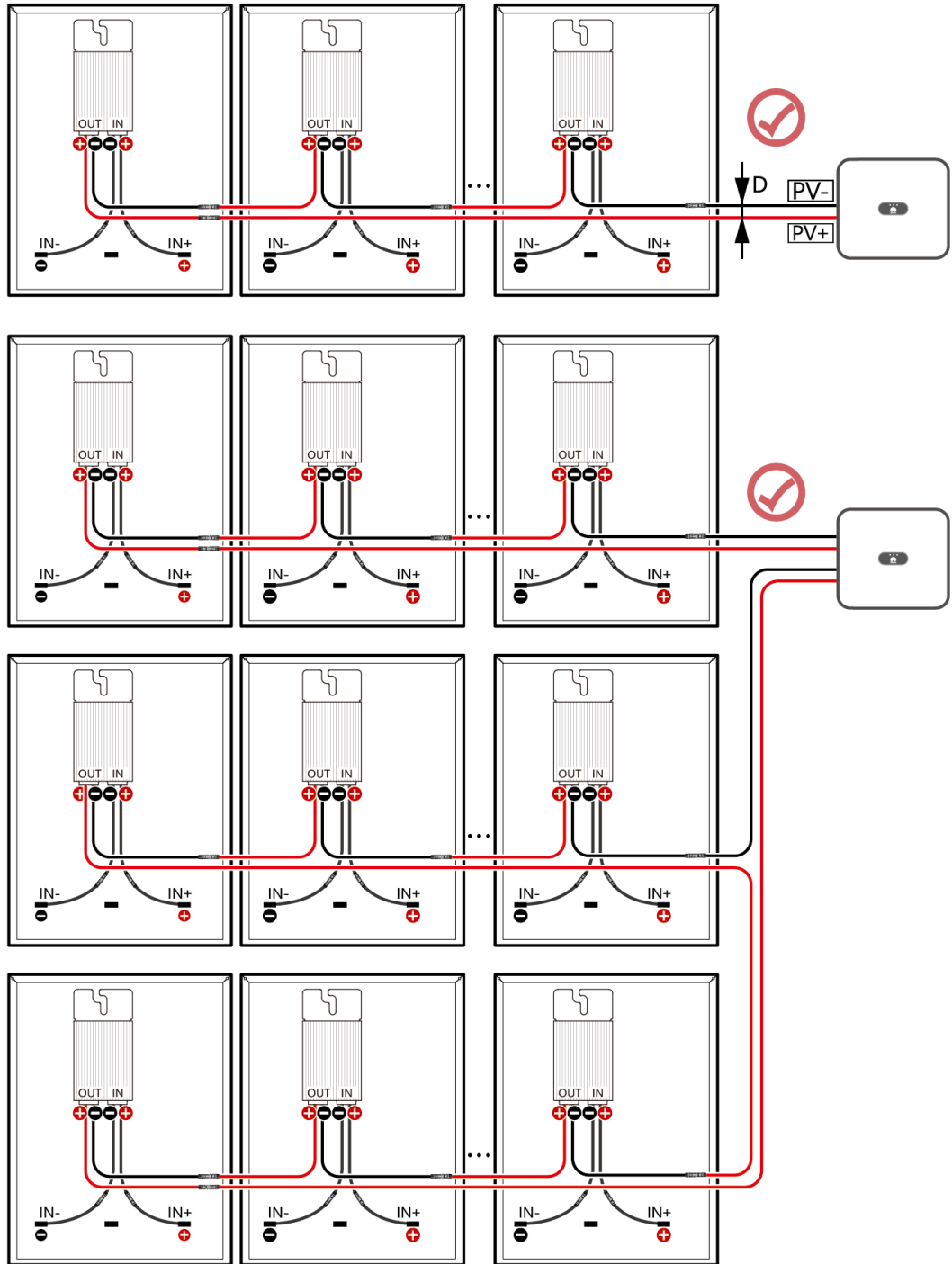
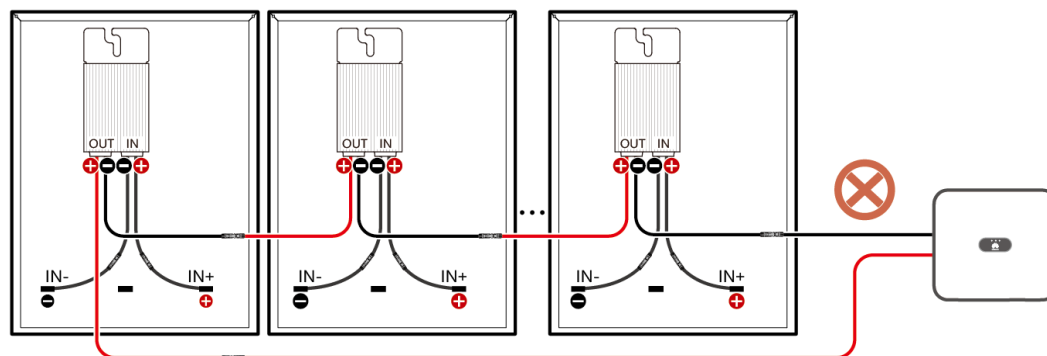


Figure 3-9 Prohibited cabling



----End

3.5 Physical Layout

The physical layout must be configured for optimizers. When an optimizer is faulty, it can be quickly located and replaced based on the physical layout.

Physical layouts of the MERC-600W-PA0 Smart PV Optimizers can be created in three ways. For details, see [FusionSolar Physical Layout User Guide](#).

- Create a physical layout on the FusionSolar app.
- Create a physical layout on the WebUI of the FusionSolar Smart PV Management System (SmartPVMS).
- Create a physical layout on the local device commissioning screen.

NOTE

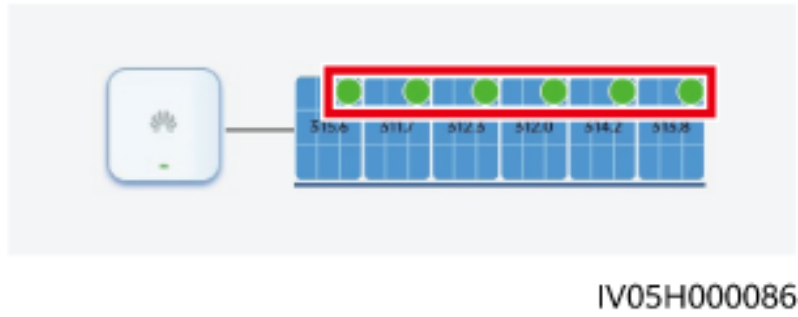
- If Smart PV Optimizers are configured for PV strings, ensure that the Smart PV Optimizers have been successfully connected to the inverter before performing other operations.
- Check that the SN labels of Smart PV Optimizers are correctly attached to the physical layout template.
- Take and save a photo of the physical layout template. Keep your phone parallel to the template and take a photo in landscape mode. Ensure that the four positioning points at the corners are in the frame and that each QR code is attached within the frame.

3.6 Checking the Optimizer Status

Step 1 Open the FusionSolar app, enter intl.fusionsolar.huawei.com, log in as an installer, choose **Services** > **Commission Device**, and connect to the WLAN hotspot of the inverter.

Step 2 Log in to the device commissioning screen of the inverter as an installer, choose **Device Monitoring**, select a string, and view the optimizer status.

Figure 3-10 Optimizer status



Status	Description
Green	The optimizer is running properly.
Gray	The optimizer is offline. Check whether the SN and location information is correct and search for the device again.
Red	The optimizer is faulty.
Yellow	The optimizer is disconnected.

----End

4 System Maintenance

 **DANGER**

- Wear personal protective equipment and use dedicated insulated tools to avoid electric shocks or short circuits.
 - Do not use wet cloth to clean exposed copper bars or other conductive parts.
-

 **WARNING**

- Before performing maintenance, power off the equipment, follow the instructions on the delayed discharge label, and wait for a period of time as specified to ensure that the equipment is not energized.
-

 **WARNING**

If the system has a change requirement, such as adding, deleting, or replacing an optimizer, adjusting the physical position of an optimizer, or adjusting the PV string input to the inverter, turn off all DC and AC switches of the inverter and wait for 5 minutes before performing the required operation to prevent personal injuries. After the change, perform optimizer search again and update the physical layout. Otherwise, the networking may be incomplete, optimizer faults cannot be located, and the system may fail.

Table 4-1 Optimizer operation description (√: allowed operations in the corresponding state; ×: prohibited operations in the corresponding state)

State (Column)/ Operation (Row)	Optimizer Search	Optimizer Log Export	Optimizer Update	Rapid Shutdown Triggering*
Inverter in on-grid mode	√	√	√	√
Inverter in off-grid mode	×	√	×	√
Inverter shutdown	×	√	√	√
Rapid shutdown	×	×	×	√

* For details about the triggering modes of rapid shutdown, see section 4.2 "Rapid Shutdown."

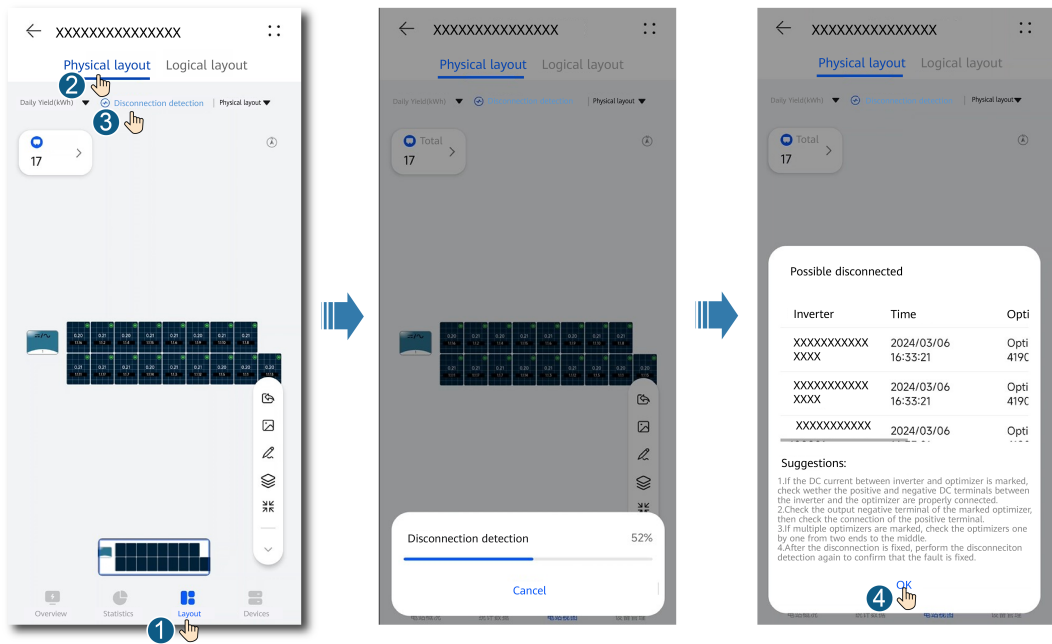
4.1 Disconnection Detection

Perform disconnection detection on optimizers and locate the disconnected ones.

Method 1: Disconnection Detection on the FusionSolar App

- Step 1** Log in to the FusionSolar app and tap the plant name on the **Home** screen to access the plant screen.
- Step 2** Choose **Layout**, tap **Disconnection detection** to check optimizer disconnection, and rectify the fault based on the result.

Figure 4-1 Optimizer disconnection detection

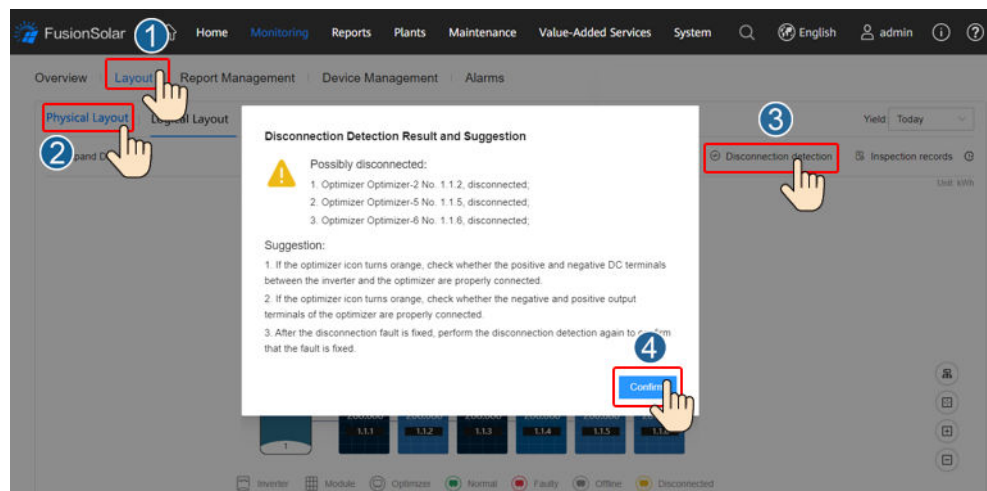


----End

Method 2: Disconnection Detection on the WebUI of the FusionSolar SmartPVMS

- Step 1** Log in to <https://intl.fusionsolar.huawei.com> to access the WebUI of the FusionSolar SmartPVMS.
- Step 2** On the **Home** page, click the plant name to go to the plant page. Choose **Layout**, tap **Disconnection detection** to check optimizer disconnection, and rectify the fault based on the result.

Figure 4-2 Optimizer disconnection detection

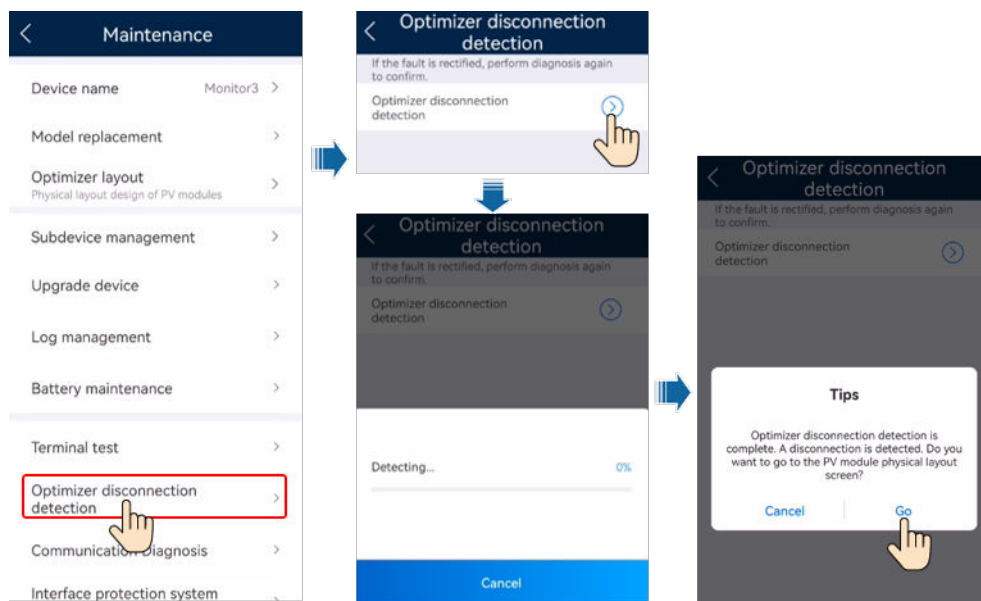


----End

Method 3: Disconnection Detection on the Local Device Commissioning Screen

- Step 1** Log in to the FusionSolar app as an installer, choose **Me > Commission Device**, and connect to the WLAN hotspot of the inverter.
- Step 2** Log in to the device commissioning screen of the inverter as an installer, choose **Maintenance > Optimizer disconnection detection**, and run the optimizer disconnection detection. After that, rectify faults based on the detection result.

Figure 4-3 Optimizer disconnection detection



----End

4.2 Rapid Shutdown

When the output is disconnected or the inverter shuts down, the optimizer can adjust the module output voltage to a safe range to ensure the safety of the construction and O&M personnel as well as firefighters.

NOTE

- You are advised to periodically check whether the rapid shutdown function is normal.

If optimizers are configured for all PV modules connected to the inverter, the PV system can perform a rapid shutdown to decrease the string voltage to a safe value within the specified timeframe.

Perform the following steps to trigger a rapid shutdown:

- Method 1: Turn off the AC switch between the inverter and the power grid.
- Method 2: Turn off the DC switch on the inverter.
- Method 3: Connect a switch to the DI and GND ports of the inverter to form a circuit. (For details about which DI port is used, see the corresponding inverter user manual.) Turn off the switch to trigger a rapid shutdown.

Table 4-2 Triggering condition (Y: rapid shutdown available; N: rapid shutdown unavailable)

Off-Grid Mode of Inverter	Turn Off DC Switch	Turn Off AC Switch	Triggered by DI Terminal
Enable	Y	N	Y
Disable	Y	Y	Y

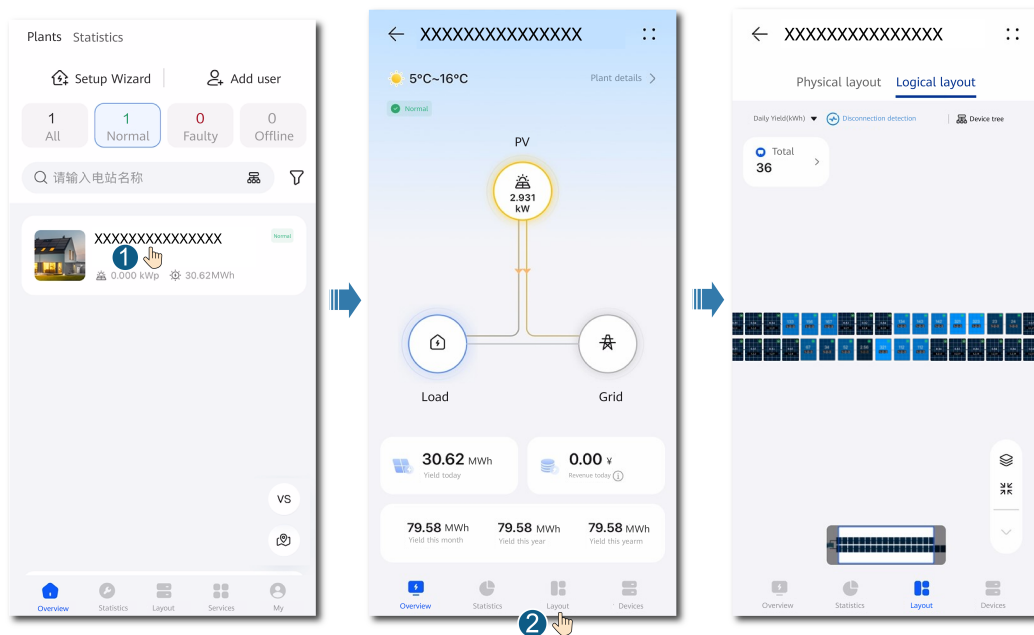
4.3 O&M for PV Modules

In the physical or logical layout, you can quickly identify low-efficiency PV modules by color.

Step 1 Log in to the FusionSolar app and tap the plant name on the **Home** screen to access the plant screen.

Step 2 Select **Layout** and quickly identify inefficient PV modules by color in the physical or logical layout.

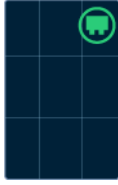





Figure 4-4 O&M for PV modules



NOTE

- When the power of PV modules under normal irradiance is the same and the colors of PV modules in the layout are similar, the PV modules are normal.
- When the power of PV modules under normal irradiance is the same but the colors of some PV modules are darker than those of the other PV modules in the layout, PV modules with darker colors may be inefficient PV modules if the module surfaces are clean and there is no shading.

Table 4-3 PV module colors

Ratio Range (Optimizer Output Power/Optimizer Rated Power)	PV Module Color	Description
0%–20%		PV module power ratio = Optimizer output power/ Optimizer rated power. The color of a PV module depends on the power ratio range. A darker color indicates a smaller power ratio, and vice versa.
20%–40%		
40%–60%		
60%–80%		
80%–100%		
Default color		

----End

4.4 Alarm List

Table 4-4 Common alarms and troubleshooting measures

Alarm Name	Cause	Suggestion
Input overvoltage	Optimizer input overvoltage occurred.	Check whether the open-circuit voltage of the PV module exceeds the maximum input voltage of the optimizer.
Internal hardware fault	An internal fault occurred in an optimizer.	Contact the installation contractor.
Output backfeed	Optimizer output backfeed occurred.	<ol style="list-style-type: none"> 1. Check whether PV modules are severely blocked when PV strings are connected in parallel. 2. If the fault persists, contact the installation contractor.
Output terminal overtemperature	The temperature of the optimizer output terminal is abnormal.	Contact the installer to replace the faulty optimizer and the optimizer connected to the short output cable of the faulty optimizer.
Input terminal overtemperature	The temperature of optimizer input terminals is abnormal.	Contact the installer to replace the faulty optimizer and the terminals of the corresponding modules.
Abnormal output voltage	The optimizer output voltage is abnormal.	<ol style="list-style-type: none"> 1. When the sunlight is normal, perform optimizer search again. 2. Use an extension cable for the optimizer output, prepare new terminals, and connect the extension cable to the positive connector at one end and to the negative connector at the other end. 3. Check whether the PV string is correctly connected to the inverter or whether there is a breakpoint in the PV string. 4. If the fault persists, contact the installation contractor.

Alarm Name	Cause	Suggestion
Upgrade failed	The optimizer software upgrade failed.	<ol style="list-style-type: none">1. When the sunlight is normal, perform the optimizer upgrade again.2. If the fault persists, contact the installation contractor.

 NOTE

Contact the service provider if all suggested measures listed above are completed and the fault still exists.

4.5 Replacing and Adding an Optimizer

 NOTE

If you want to add an optimizer for a PV module you purchased, log in to the FusionSolar app and tap the PV plant name on the **Home** screen to access the plant screen. Choose **Devices > Inverter**, select the corresponding inverter, tap **Optimizer search**, and perform operations as prompted to search for optimizers.

4.5.1 Scenario 1: Replacing an Optimizer (on the FusionSolar App)

Prerequisites

- Use dedicated insulated tools, and wear insulated shoes and insulated gloves before performing operations.
- A new Smart PV Optimizer is available.

Procedure

Step 1 Wear insulated gloves.

Step 2 Power off the inverter.

Step 3 Disconnect the input terminals of the optimizer.

Step 4 Remove the old optimizer.

1. Record the cable connection positions on the optimizer and disconnect the output terminals of the optimizer.
2. Loosen the bolt that secures the optimizer and remove the optimizer.

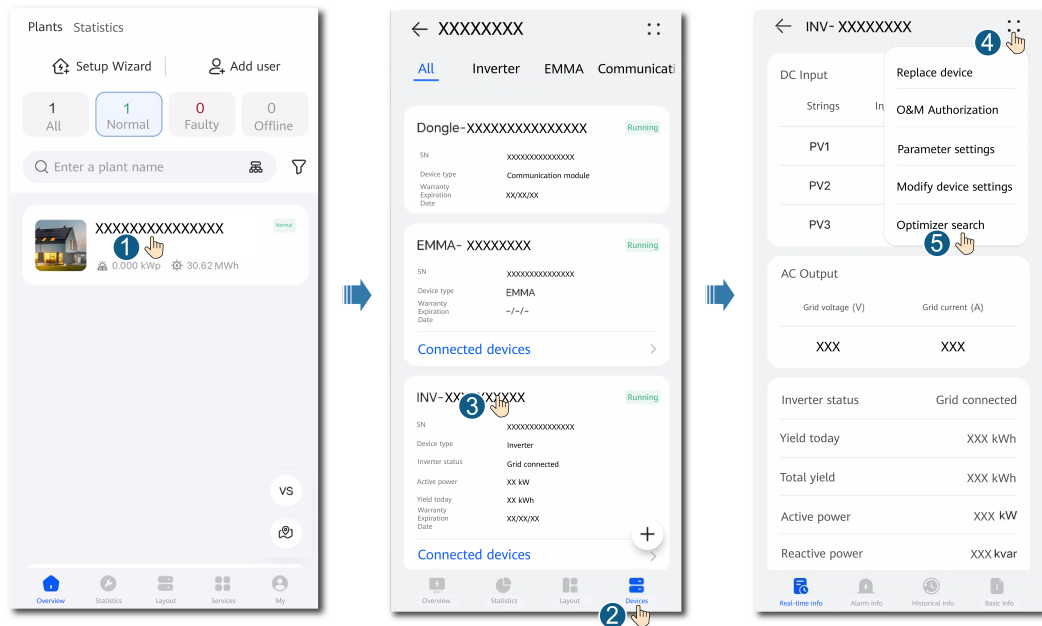
Step 5 Install a new optimizer.

1. Secure the new optimizer to the corresponding bolt and tighten the bolt.
2. Connect the cables to the new optimizer based on the recorded information.

 **NOTE**

If multiple optimizers need to be replaced, record the optimizer numbers.

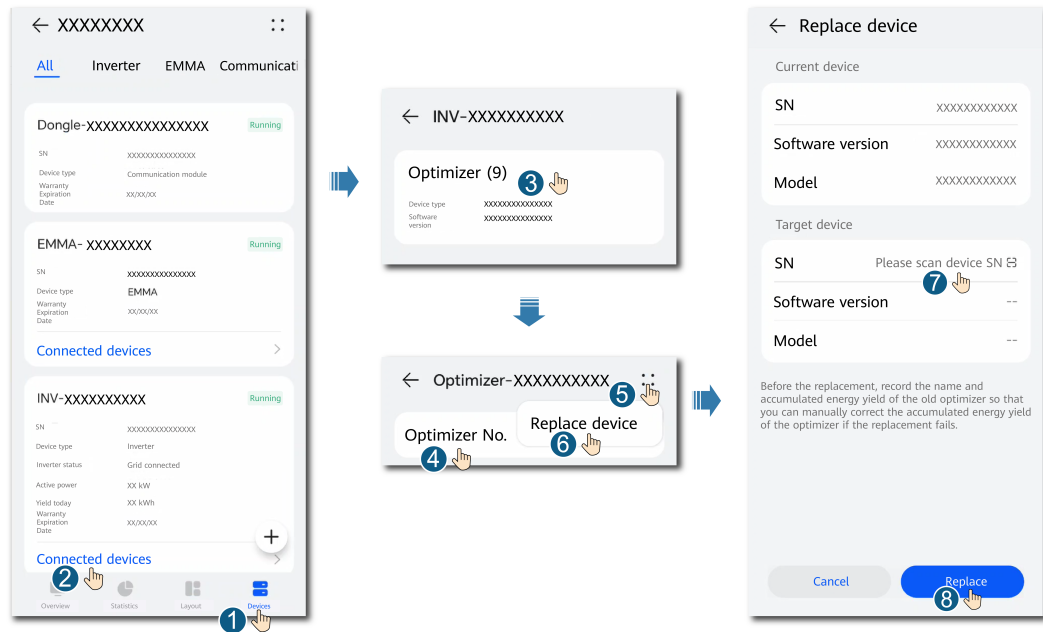
Step 6 Power on the inverter. Log in to the FusionSolar app and tap the plant name on the **Home** screen to access the plant screen. Choose **Devices > Inverter**, select the corresponding inverter, tap **Optimizer search**, and perform operations as prompted to search for optimizers.



Step 7 Choose **Devices > Connected devices > Optimizer**, tap **Optimizer No.**, select the faulty optimizer, tap **Replace device**, and replace the optimizer as prompted.

 **NOTE**

- If *N* optimizers need to be replaced, perform the preceding procedure for *N* times.
- After the optimizer is replaced, the new optimizer automatically inherits the energy yield, physical layout, and logical layout of the faulty optimizer.



----End

4.5.2 Scenario 2: Replacing an Optimizer (on the Local Device Commissioning Screen)

Prerequisites

- Use dedicated insulated tools, and wear insulated shoes and protective gloves before performing operations.
- A new Smart PV Optimizer is available.

Procedure

Step 1 Wear protective gloves.

Step 2 Power off the inverter.

Step 3 Disconnect the input terminals of the optimizer.

Step 4 Remove the old optimizer.

1. Record the cable connection positions on the optimizer and disconnect the output terminals of the optimizer.
2. Loosen the bolt that secures the optimizer and remove the optimizer.

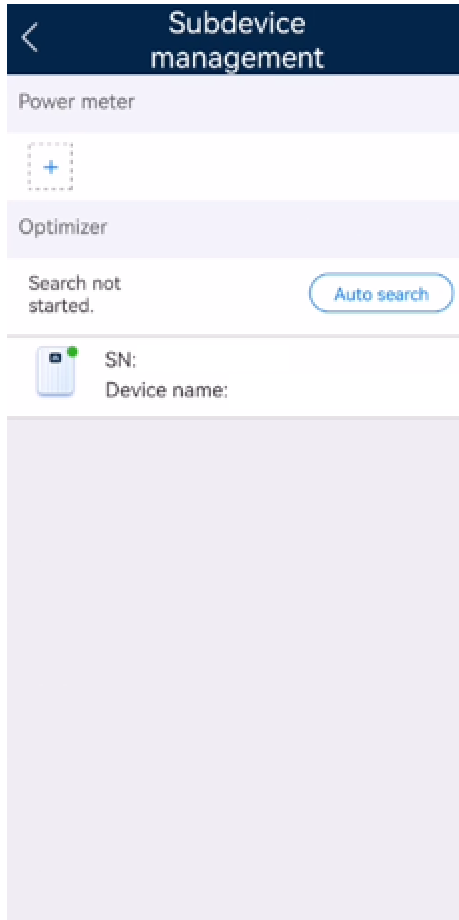
Step 5 Install a new optimizer.

1. Secure the new optimizer to the corresponding bolt and tighten the bolt.
2. Connect the cables to the new optimizer based on the recorded information.

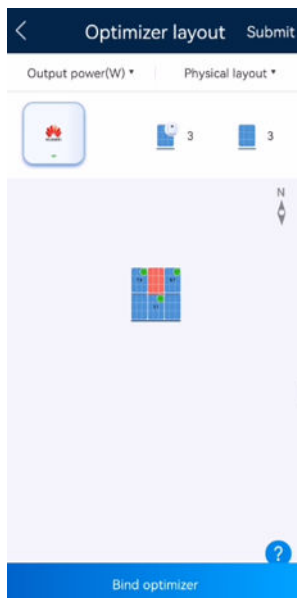
NOTE

If multiple optimizers need to be replaced, record the mapping information.

Step 6 Power on the inverter. On the device commissioning screen, choose **Maintenance** > **Subdevice management**, and tap **Auto search** to add the new optimizer.



Step 7 On the device commissioning screen, choose **Maintenance > Optimizer layout**, select the corresponding PV module, and bind the new optimizer according to the recorded mapping information. Tap **Submit**.



----End

4.5.3 Scenario 3: Replacing an Optimizer (on the FusionSolar SmartPVMS)

Prerequisites

- Use dedicated insulated tools, and wear insulated shoes and protective gloves before performing operations.
- A new Smart PV Optimizer is available.

Procedure

Step 1 Wear protective gloves.

Step 2 Power off the inverter.

Step 3 Disconnect the input terminals of the optimizer.

Step 4 Remove the old optimizer.

1. Record the cable connection positions on the optimizer and disconnect the output terminals of the optimizer.
2. Loosen the bolt that secures the optimizer and remove the optimizer.

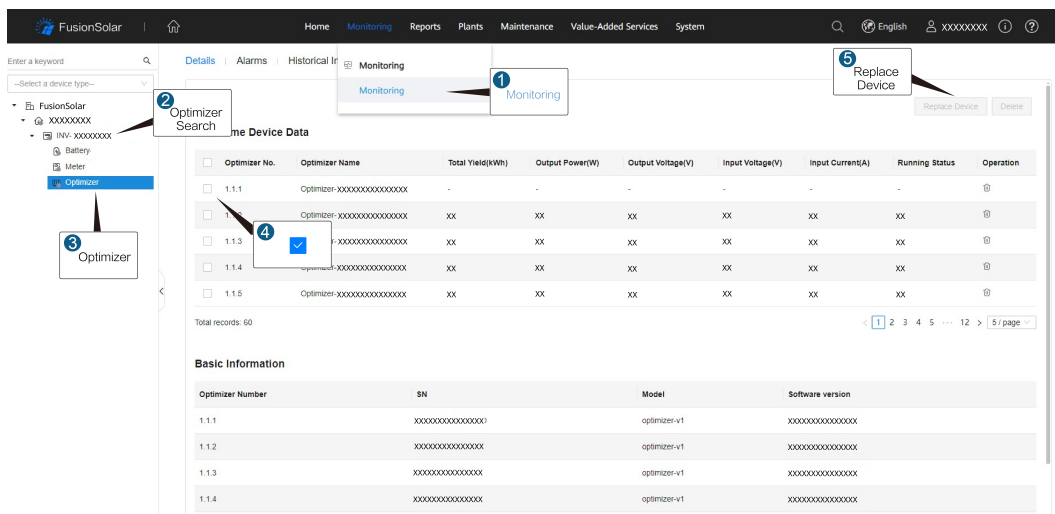
Step 5 Install a new optimizer.

1. Secure the new optimizer to the corresponding bolt and tighten the bolt.
2. Connect the cables to the new optimizer based on the recorded information.

 **NOTE**

If multiple optimizers need to be replaced, record the mapping information.

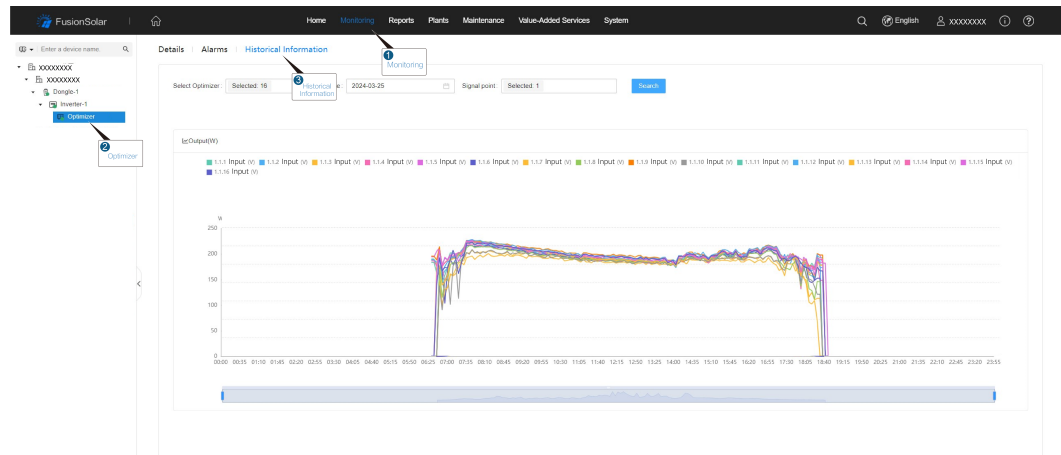
Step 6 Power on the inverter. On the **Monitoring** page of the FusionSolar SmartPVMS, click the inverter to which the optimizer belongs in the left pane and click **Optimizer Search**. After the search is complete, find and click the optimizer in the left pane, select the old optimizer to be replaced, click **Replace Device** in the upper right corner, and enter the SN of the new optimizer as prompted to complete optimizer replacement.



----End

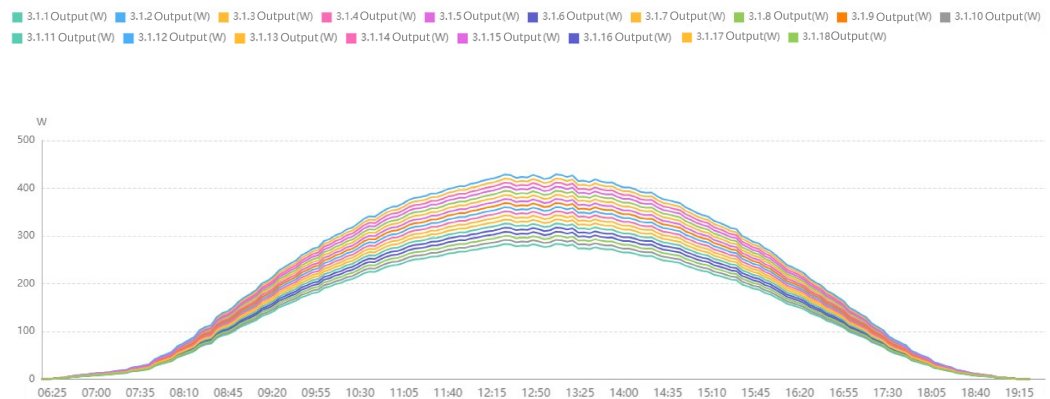
4.6 Troubleshooting Suggestions Against Inefficient PV Modules

If a PV module is shaded or faulty, its energy yield may be lower than that of other modules. You can access the **Monitoring** page of the FusionSolar SmartPVMS, click **Optimizer** in the left pane, click **Historical Information**, and select optimizers to view the historical information about each PV module.



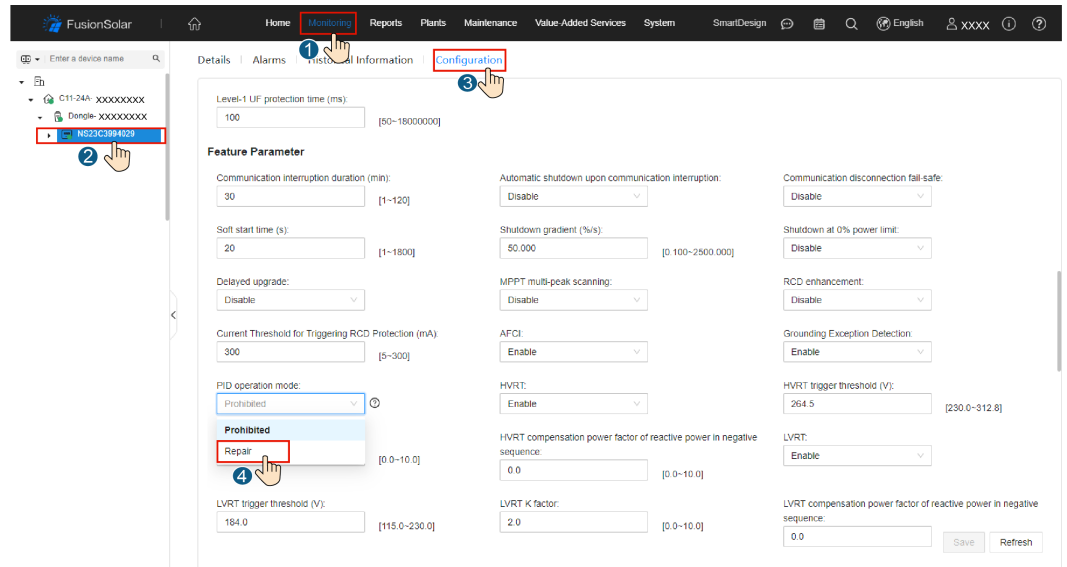
PID

Potential induced degradation (PID) can significantly reduce the power output of PV modules. If PID does not occur, the output power of different modules in the same PV string should be similar, and their curves should be roughly overlapped. If PID occurs, the output power curves are scattered, as shown in the following figure.



Suggestion:

1. If the inverter supports PID recovery, access the **Monitoring** page of the FusionSolar SmartPVMS, click **Inverter** in the left pane, click **Configuration**, and select **Repair** for **PID operation mode**.

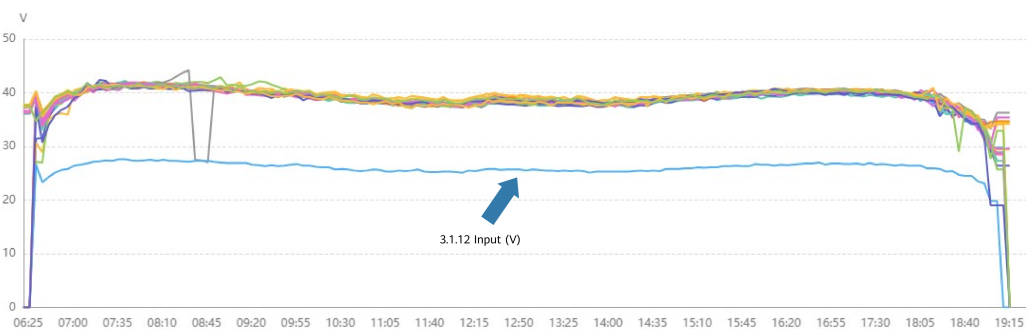


2. If the exception persists, contact your PV module vendor or manufacturer.

Bypass Diode Short-Circuit

If the bypass diode is short-circuited, the input voltage of the affected module will decrease. As shown in the figure, the input voltage of module 3.1.12 (blue) is much lower than that of other modules in the PV string.

■ 3.1.1 Input (V) ■ 3.1.2 Input (V) ■ 3.1.3 Input (V) ■ 3.1.4 Input (V) ■ 3.1.5 Input (V) ■ 3.1.6 Input (V) ■ 3.1.7 Input (V) ■ 3.1.8 Input (V) ■ 3.1.9 Input (V)
■ 3.1.10 Input (V) ■ 3.1.11 Input (V) ■ 3.1.12 Input (V) ■ 3.1.13 Input (V) ■ 3.1.14 Input (V) ■ 3.1.15 Input (V) ■ 3.1.16 Input (V)
■ 3.1.17 Input (V) ■ 3.1.18 Input (V)

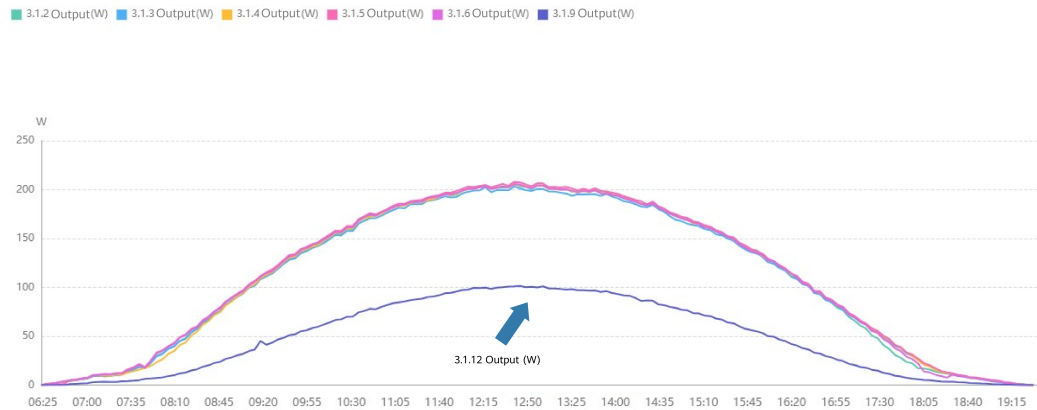


Suggestion:

1. Check whether the PV module is shaded or foreign objects exist. If so, eliminate the shade, remove foreign objects, or clean the PV module.
2. Use a voltmeter to measure the voltage of the PV module onsite. If the voltage reading is obviously lower than 1/3 or 2/3 of the nominal open-circuit voltage, contact your PV module vendor or manufacturer to replace the PV module with a new one of the same model.
3. If the exception persists, contact your PV module vendor or manufacturer.

Abnormal PV Module Attenuation

If a PV module attenuates abnormally, its output power will decrease. As shown in the figure, the output power of module 3.1.9 is significantly lower than that of other modules in the same PV string.



Suggestion:

1. Check whether the PV module is shaded or foreign objects exist. If so, eliminate the shade, remove foreign objects, or clean the PV module.
2. If there is no shading or foreign objects, check the PV module for glass panel breakage. If the glass panel is broken, replace the PV module with a new one of the same model.
3. If the exception persists, contact your PV module vendor or manufacturer.

4.7 PV Module-Level Diagnosis

PV module-level diagnosis detects potential faults in an inefficient PV string in a timely manner. For details, see [FusionSolar Physical Layout User Guide](#).

- Identify faulty PV modules on the FusionSolar SmartPVMS.
- View the PV module diagnosis report on the FusionSolar app.

5 Technical Specifications

5.1 MERC-600W-PA0 Technical Specifications

Efficiency

Item	MERC-600W-PA0
Maximum efficiency	99.5%
European weighted efficiency	99.0%

Input

Item	MERC-600W-PA0
Rated PV module power	600 W
Maximum PV module power	630 W
Maximum input voltage	80 V
MPPT voltage range	10–80 V
Maximum short-circuit current	16 A
Overvoltage category	II

Output

Item	MERC-600W-PA0
Rated output power	600 W
Output voltage	1–80 V
Maximum output current	16 A
Output bypass	Yes
Shutdown output voltage	1 V ($\pm 5\%$)

General Specifications

Item	MERC-600W-PA0
Dimensions (H x W x D)	73.8 mm x 145 mm x 27.2 mm
Net weight	≤ 650 g
DC input and output terminals	Staubli MC4
Operating temperature ^a	-40°C to $+85^{\circ}\text{C}$
Storage temperature	-40°C to $+70^{\circ}\text{C}$
Operating humidity	0–100% RH
Maximum operating altitude	4000 m
IP rating	IP68
Installation mode	<ul style="list-style-type: none"> ● PV module support installation ● PV module frame installation

6 FAQ

6.1 How Do I Identify a Faulty Optimizer by Measuring the Voltage?

Use a multimeter to measure the voltage of the PV string when the irradiance is adequate. The voltage level of the multimeter affects the measurement precision of the PV string output voltage. Select the minimum voltage level that meets the measurement requirements.

A normal measurement result shall meet the following requirement: PV string voltage = $V_1 + V_2 + \dots + V_N \approx N \times 1 \text{ V}$. For example, if there are 16 optimizers in a PV string, the PV string voltage is about 16 V ($\pm 5\%$). If the PV string voltage measurement result is abnormal, check the voltage of each optimizer by referring to the measurement method shown in the following figure.

Figure 6-1 Measuring the voltage of an optimizer

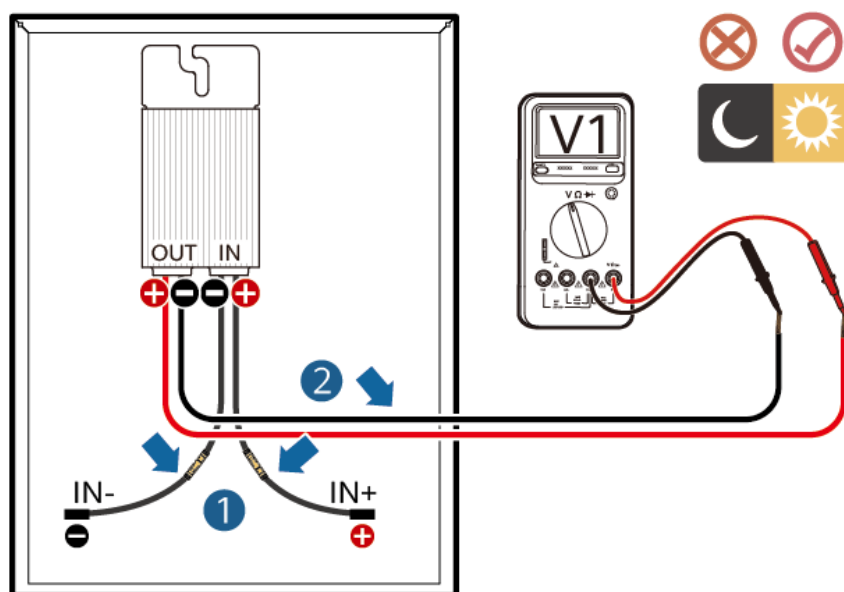


Table 6-1

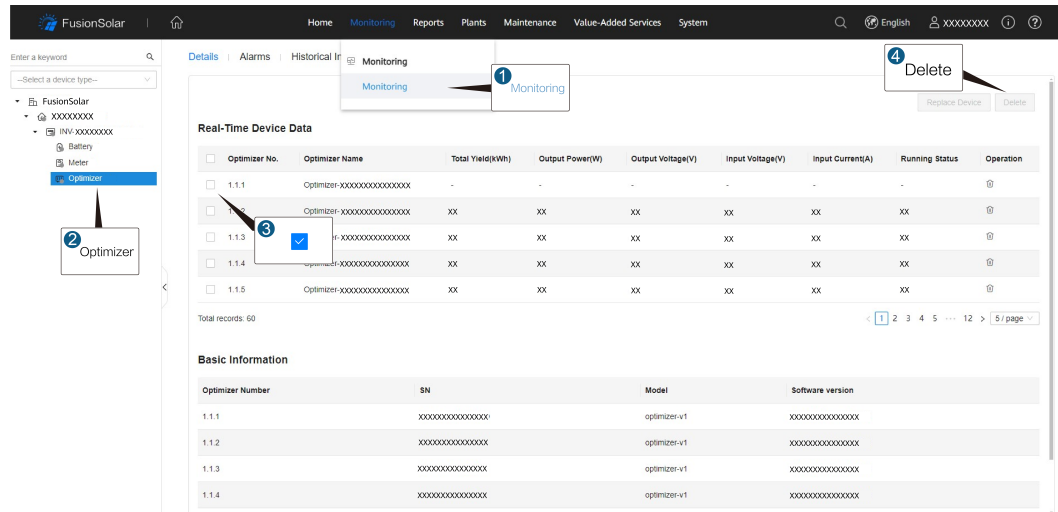
Voltage	Cause	Suggestion
$0.95\text{ V} \leq V1 \leq 1.05\text{ V}$	The optimizer is normal.	-
$V1 > 1.05\text{ V}$	The optimizer is faulty.	Replace the optimizer.
$V1 < 0.95\text{ V}$	<ul style="list-style-type: none"> • The irradiance is low. • The optimizer input power cables are not connected. • Optimizer cables are incorrectly connected. • The optimizer is faulty. • The PV module is faulty. 	<ol style="list-style-type: none"> 1. Measure the voltage when the irradiance is adequate. 2. Connect the optimizer input power cables. 3. Correct the optimizer cable connections. Connect the optimizer input power cables to the PV module output power cables. 4. If the voltage is still abnormal, replace the optimizer. 5. Measure the PV module voltage. If the voltage is abnormal, replace the PV module.
$V1 \approx -1\text{ V}$	The probes are reversely connected.	Reconnect the positive and negative probes correctly.

6.2 How Do I Delete an Optimizer and Update the Physical Layout (on the FusionSolar SmartPVMS)?

If you do not replace the optimizer according to [4.5.1 Scenario 1: Replacing an Optimizer \(on the FusionSolar App\)](#), [4.5.2 Scenario 2: Replacing an Optimizer \(on the Local Device Commissioning Screen\)](#), or [4.5.3 Scenario 3: Replacing an Optimizer \(on the FusionSolar SmartPVMS\)](#), you may see that the old optimizer is offline on the FusionSolar SmartPVMS. In this case, you can perform the following steps to delete the old optimizer:

Procedure

- Step 1** Power on the inverter. On the **Monitoring** page of the FusionSolar SmartPVMS, click **Optimizer** in the left pane, select the optimizer to be replaced, click **Delete** in the upper right corner, and delete the old optimizer as prompted.



Step 2 After deleting the old optimizer, update the physical layout. The physical layout must be configured for optimizers. When an optimizer is faulty, it can be quickly located and replaced based on the physical layout. For details, see the [FusionSolar Physical Layout User Guide](#).

----End

6.3 How Do I Obtain Contact Information?

If you have any questions about this product, please contact us.



<https://digitalpower.huawei.com>

Path: **About Us > Contact Us > Service Hotlines**

To ensure faster and better services, we kindly request your assistance in providing the following information:

- Model
- Serial number (SN)
- Software version
- Alarm ID or name
- Brief description of the fault symptom

 **NOTE**

EU Representative Information: Huawei Technologies Hungary Kft.
Add.: HU-1133 Budapest, Váci út 116-118., 1. Building, 6. floor.
Email: hungary.reception@huawei.com

A Acronyms and Abbreviations

A

APP	application
ASIC	application-specific integrated circuit

D

DC	direct current
-----------	----------------

E

EMC	electromagnetic compatibility
ESD	electrostatic discharge

G

GND	ground
------------	--------

I

ID	identifier
-----------	------------

L

LSI	large-scale integration
------------	-------------------------

M

MPPT	maximum power point tracking
-------------	------------------------------

P

PV	photovoltaic
-----------	--------------

S

SN	serial number
W	
WLAN	wireless local area network